

Class-12

ZOOLOGY

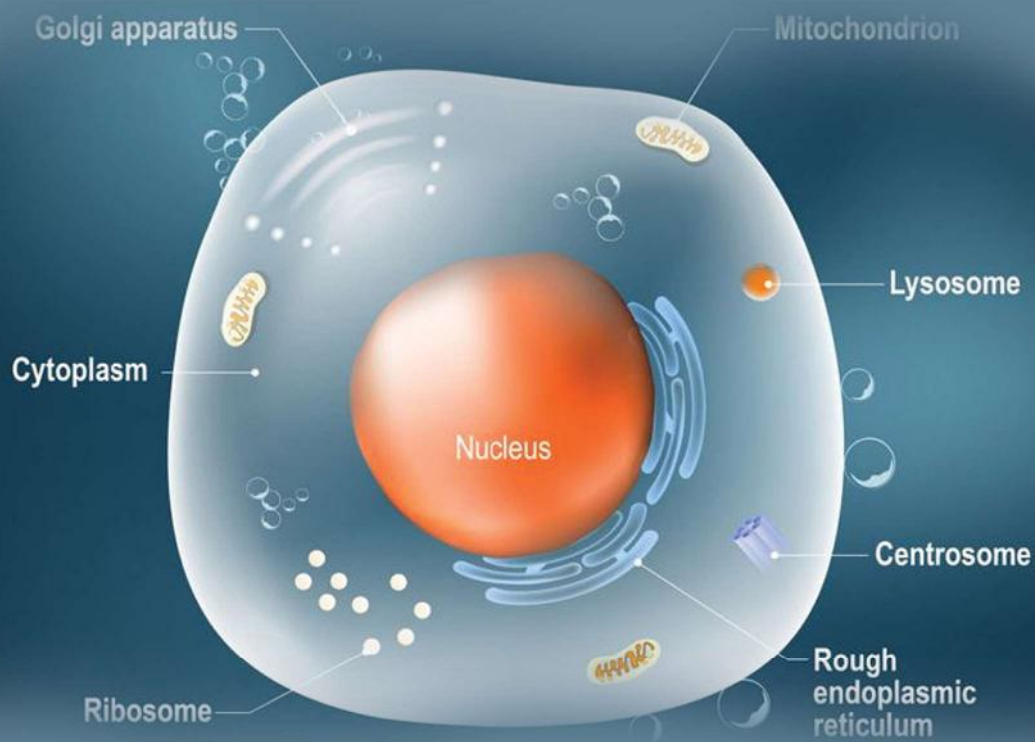

GENERAL EDUCATION DEPARTMENT
SAMAGRA SHIKSHA KERALA

CHAPTER 1

HUMAN REPRODUCTION

MALE REPRODUCTIVE SYSTEM

- In humans, **sexes are separate**. In male, **testis** produce **sperm**, and in female, **ovary** produce **egg**.
- Humans exhibit sexual dimorphism.
- External morphology is different in male and females.
- Male → Testis → Sperm
- Female → Ovary → Egg/Ova
- Male reproductive system consists of a pair of testes, duct system, accessory glands and penis.
- Testis produce male gamete (sperm) and male sex hormones called **androgens**.
- Testis are held outside the abdomen, in a pouch called the **scrotum** which keep optimum temperature 2 - 2.5⁰C below the normal body temperature. It is necessary for sperm production.
- Penis is an organ for sperm transfer.
- Testis is composed of highly coiled structures called **seminiferous tubules** in which **sperms are produced**.
- Seminiferous tubules contain two types of cells: **Male germ cells** and **Sertoli cells**.
- Male germ cells help in sperm formation and **Sertoli cells provide nutrition to germ cells**.
- Outside the seminiferous tubules are present the interstitial cells or **leydig cells** which synthesise and **secrete androgens**

Diagrammatic View of Male Reproductive System

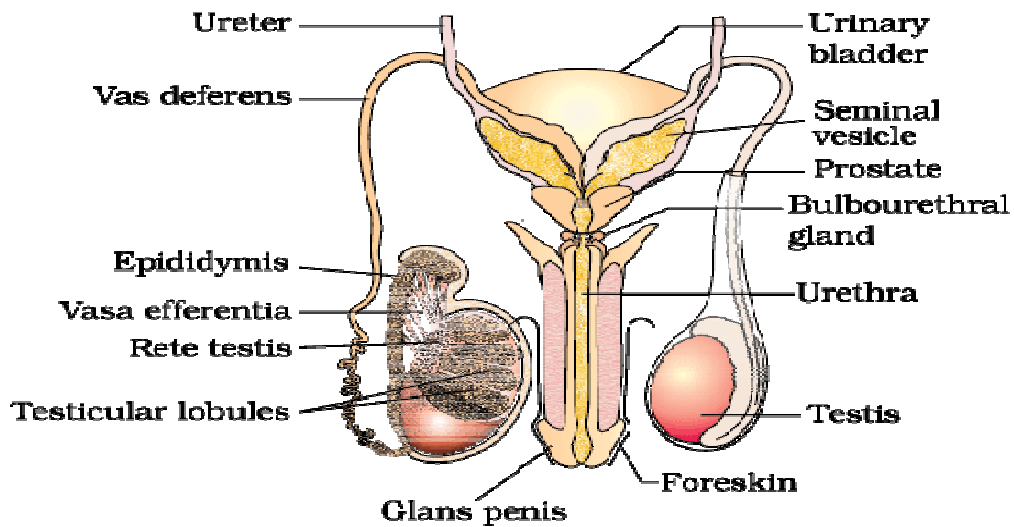

- The important glands are:
 - 1. Seminal Vesicle
 - 2. Bulbourethral Gland
 - 3. Prostate Gland
- } Secretions are called seminal plasma:
It is rich in fructose, calcium and some enzyme.
- The male accessory ducts are:
 - Seminiferous tubules → rete testis → vasa efferentia → epididymis
 - vas deferens → ejaculatory duct → urethra → urethral meatus.

SELF CHECK QUESTIONS

1. What are the functions of testes?
2. What is scrotal sac? Why is it located outside the abdominal cavity?
3. Write the functions of sertoli cells.
4. Name the accessory glands in male reproductive system.
5. Leydig cell produce hormones called -----

FEMALE REPRODUCTIVE SYSTEM

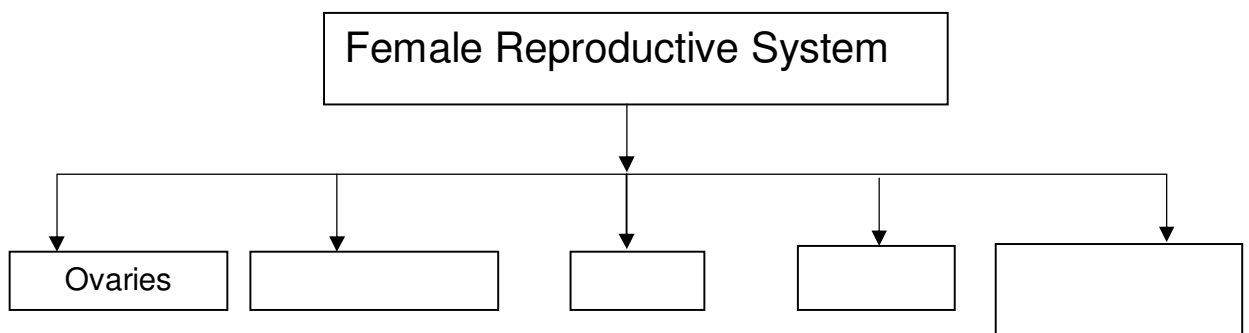
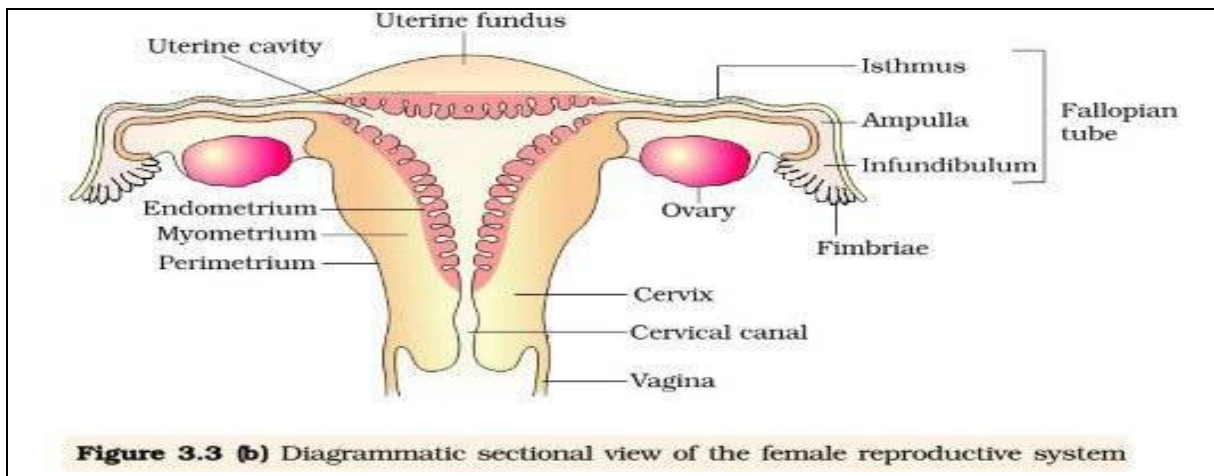

Ans: fallopian tubes (oviducts), Uterus, cervix, Vagina

- Ovary is almond shaped 3cm long, located close to the wall of pelvic cavity.
- Produce female gamete (ovum) and ovarian hormones: **Estrogen and Progesterone.**

Oviducts (Fallopian Tube):

- Extends from each ovary to uterus.
- There are 3 parts in oviduct-
 - 1) A funnel shaped **infundibulum** with finger-like projections at the edges called **fimbriae.**
 - 2) **Ampulla**- a wider part of oviduct.

3) **Isthmus**- narrow part which joins uterus

- **Fimbriae** collects ovum after ovulation.
- Fertilisation takes place in **ampullary region** of oviduct

Uterus:

- Pear shaped muscular sac.
- There are 3 layers:
 - 1) Perimetrium- Outer layer
 - 2) Myometrium- Middle layer
 - 3) Endometrium- Inner layer
- Endometrium undergoes cyclic changes during menstrual cycle.

Implantation takes place in **endometrium**.

Hymen:

- Hence, hymen is not a reliable indicator of virginity.
- A membrane covering vaginal opening.
- The hymen is often torn out during the first coitus. However, it can also be broken by a sudden fall, active participation in some sports like horseback riding, cycling etc.

SELF CHECK QUESTIONS

1. Write the functions of ovary.
2. Fertilisation takes place in _____ of oviduct
3. Name the layers of uterus.
4. Name different parts in oviduct.
5. Name the different parts in female reproductive system.

GAMETOGENESIS

The production of haploid gametes in gonads is called **Gametogenesis**. Both these gametes originate from **primordial germ cells**.

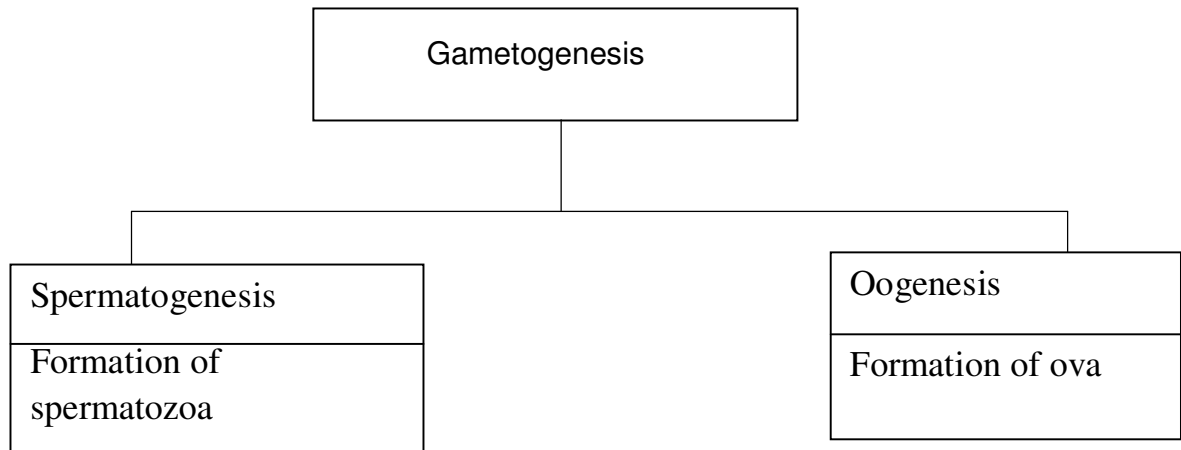
**Spermatogenesis:**

- Primordial germ cells in seminiferous tubules, undergo repeated mitotic division to form spermatogonia.
- **Spermatogonia** undergo growth and become **primary spermatocyte**.
- Primary spermatocyte is diploid because it possesses 46 chromosomes. (2 sets)
- Primary spermatocyte undergoes **1st meiosis** and give 2 haploid secondary spermatocytes, each containing 23 chromosomes.
- The Secondary spermatocytes undergo the second meiotic division to form four spermatids. Thus from one primary spermatocyte, 4 spermatids are formed.
- Spermatids differentiate into mature spermatozoa by a series of changes called **spermiogenesis**.

Spermatogenesis:

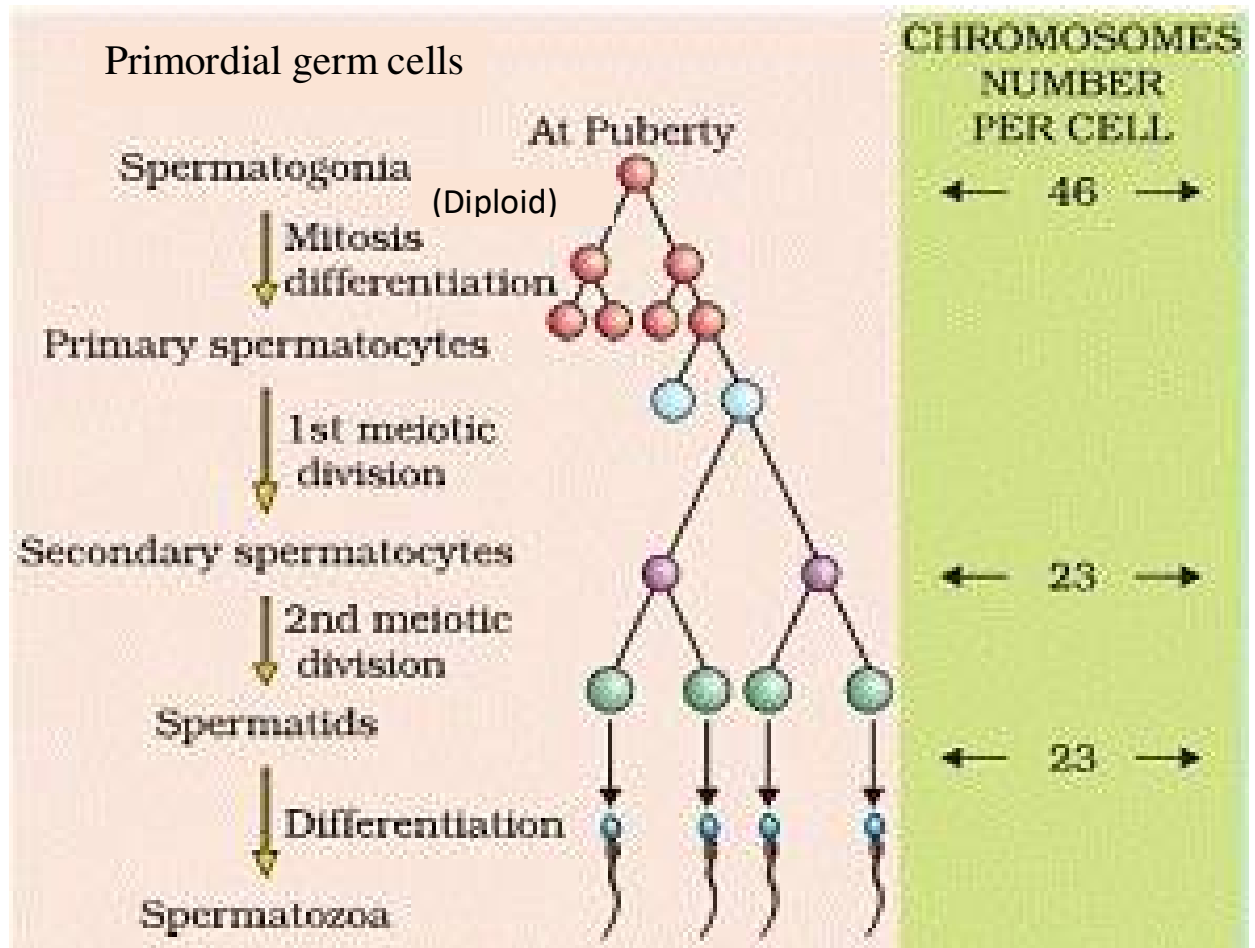

Structure of a mammalian sperm:

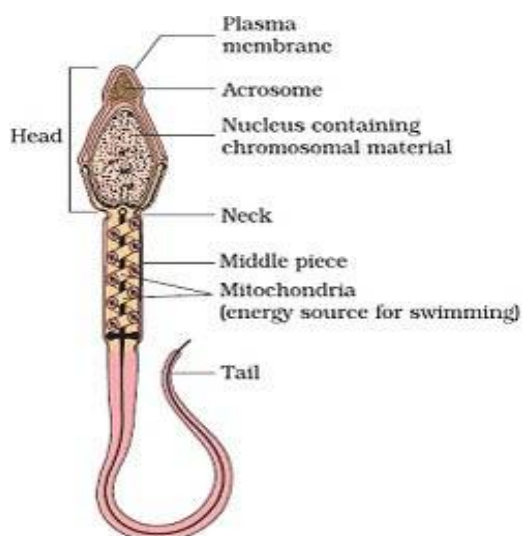

- 1) Head: Contains acrosome and nucleus.
- 2) Neck: Connects head to middle piece.
- 3) Middle piece: Contains mitochondria, which produce energy for the movement of tail.
- 4) Tail: Facilitates sperm motility.

Function of Acrosome : It is filled with enzymes that help in fertilisation of ovum.

Hormonal control of spermatogenesis

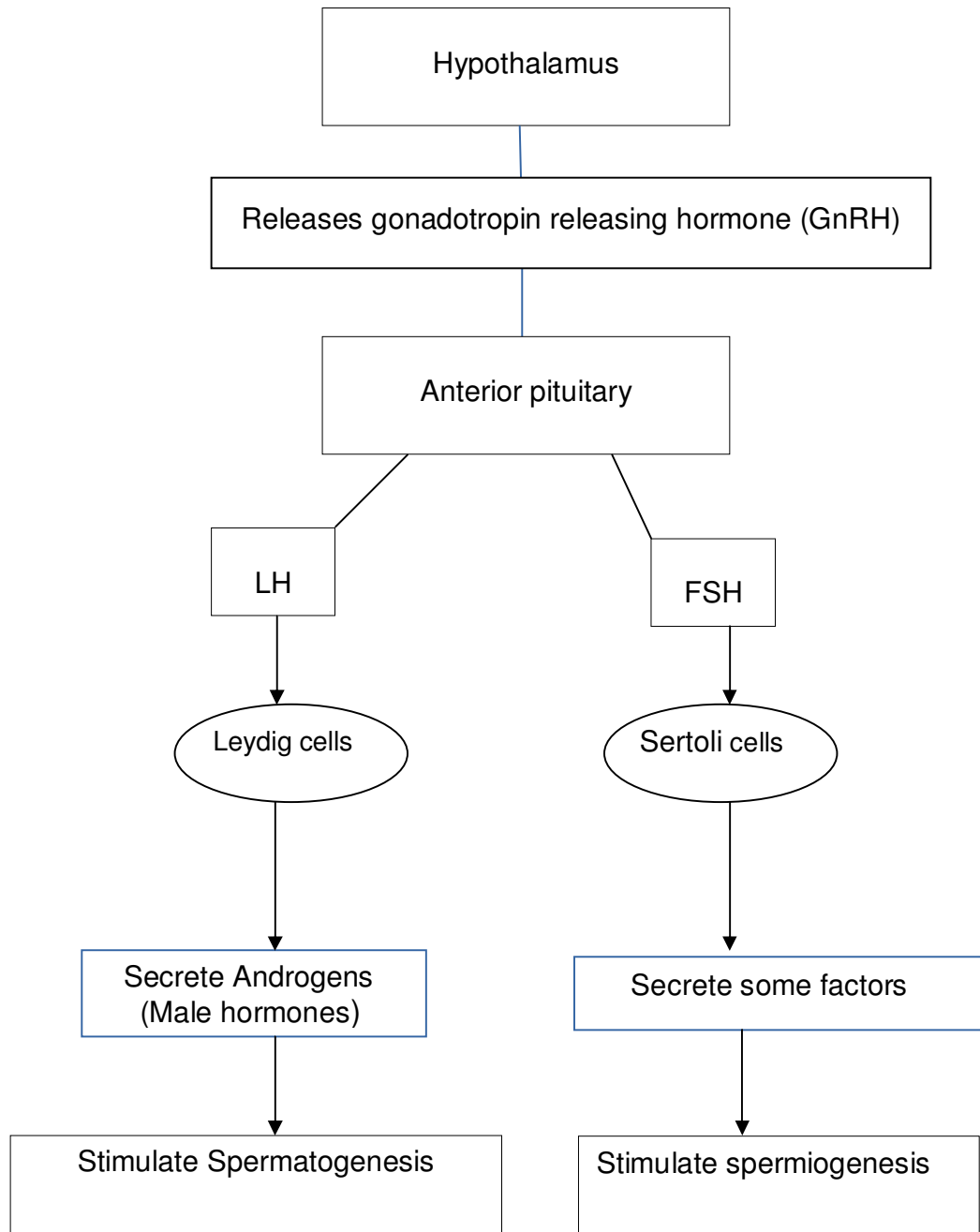

Oogenesis: Formation of ovum

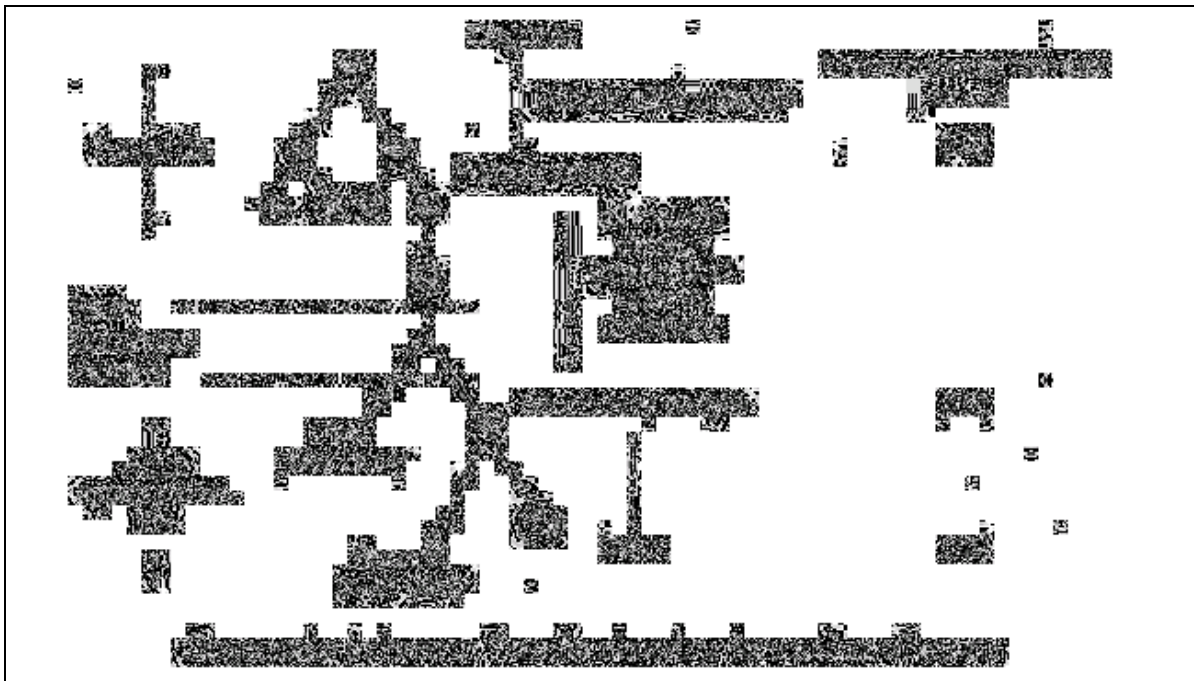

Difference between spermatogenesis and oogenesis

Spermatogenesis	Oogenesis
1. Occurs inside the testis.	1. Occurs inside the ovary.
2. From one primary spermatocyte, four sperms are produced.	2. From one primary oocyte, only one ovum is produced.
3. Polar bodies are not formed.	3. Polar bodies are formed
4. Starts at puberty	4. Starts during embryonic stage
5. It is a continuous process throughout life.	5. It terminates at menopause

Menstrual Cycle

- The reproductive cycle in female is called menstrual cycle
- Menstrual cycle is regulated by pituitary hormones LH and FSH (gonadotropins)
- Ovarian hormones like estrogen and progesterone also play an important role in menstrual cycle.

Role of hormones

FSH stimulate primary follicles to form mature **graafian follicles**.

- LH stimulate graafian follicles and help in ovulation.
- After ovulation, the graafian follicles are transformed into **Corpus luteum** .
- Corpus luteum secretes **Progesterone**
- Progesterone is essential for the development of the endometrium for implantation and maintenance of pregnancy

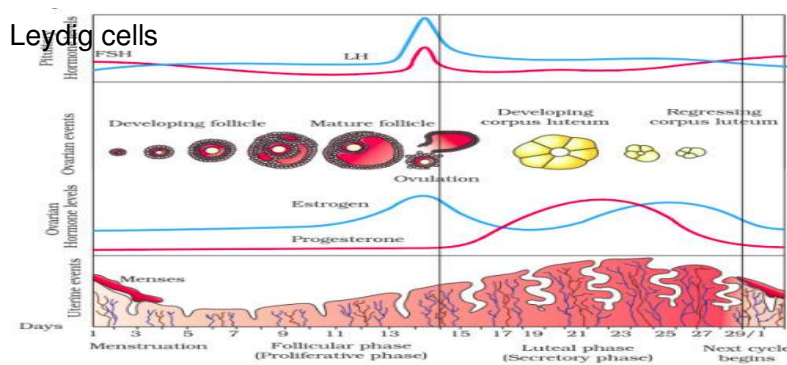

Graphical representation showing different events in menstrual cycle

SELF CHECK QUESTIONS:

1. Write the ovarian hormones involved in menstrual cycle.
2. Name the pituitary hormones regulating menstrual cycle.
3. What is corpus luteum? Write its significance.
4. Corpus luteum secretes hormone called _____

FERTILISATION AND IMPLANTATION

- Fertilisation is the fusion of male and female gamete inside the **ampulla** of oviduct.
- Division of zygote into blastomeres is called **cleavage**.
- The embryo at 16- celled stage is called **morula**.
- Morula develops into **blastocyst**.

Blastocyst has two types of cells- peripheral cells are called **trophoblast** cells and the inner hanging cells are called **inner cell mass**.

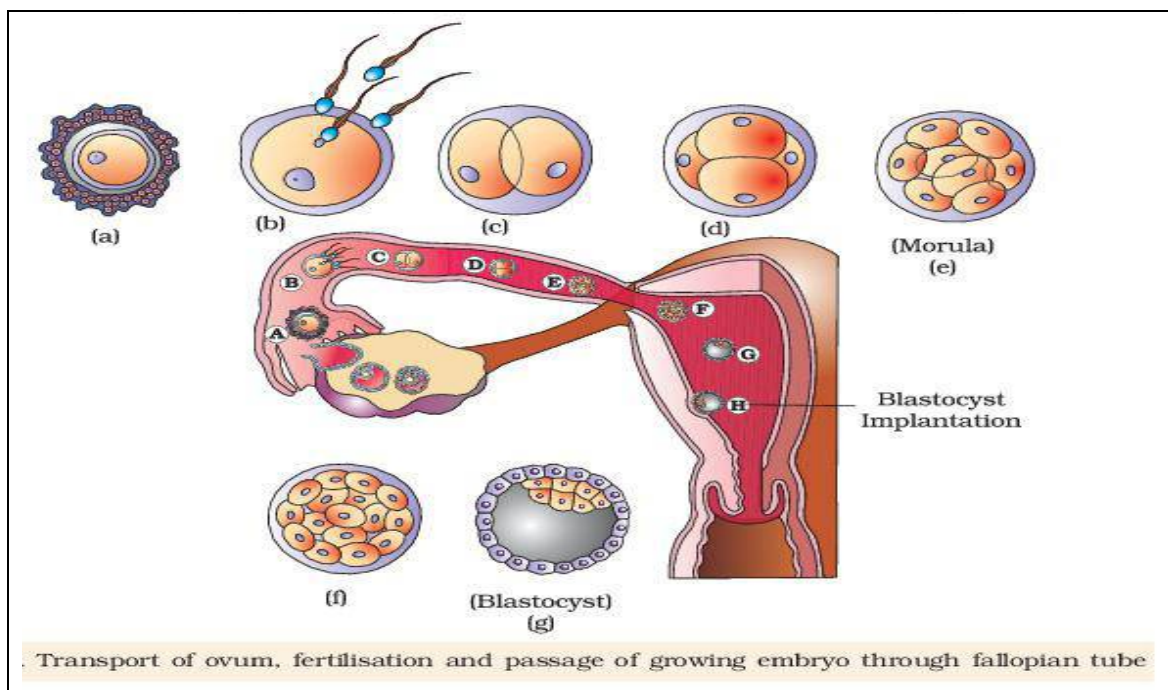

- Blastocyst is attached to the endometrium. It is called **implantation**.

Zygote → Morula → Blastocyst → Implantation

SELF CHECK QUESTIONS

1. What is cleavage?
2. What are blastomeres?
3. What is morula?
4. What is implantation?

PREGNANCY AND EMBRYONIC DEVELOPMENT

Placenta is a temporary association between foetus and maternal tissue. It acts as structural and functional unit between maternal tissue and foetal tissue.

Functions of Placenta:

- Supply nutrients, hormones, antibodies to foetus.
- Help in exchange of gases between mother and foetus.
- Help in elimination of waste of the foetus.
- Acts as an endocrine gland.
 - During later stage of pregnancy, ovary secretes a hormone called **Relaxin**.
 - Relaxin help in the formation of birth canal

SELF CHECK QUESTIONS

1. Write the functions of placenta.
2. Placenta acts as an endocrine gland. Justify.

PARTURITION AND LACTATION**Parturition:**

The process of giving birth to young ones is termed as Parturition.

Lactation:

Milk produced by mother during initial few days of lactation is known as **Colostrum**.

It is rich in protein and nutrients. Colostrum contains antibodies like IgA that provide passive immunity to the newborn baby.

SELF CHECK QUESTIONS:

1. What is parturition?
2. Which hormone is secreted by ovary during later stage of pregnancy?
3. What is colostrum? What is its significance?

CHAPTER -2
REPRODUCTIVE HEALTH

What are reproductive organs?

What is reproductive health?

In India, RCH (Reproductive and Child Health Care Programme) was introduced to attain reproductive health as a social goal

Objectives of RCH programme

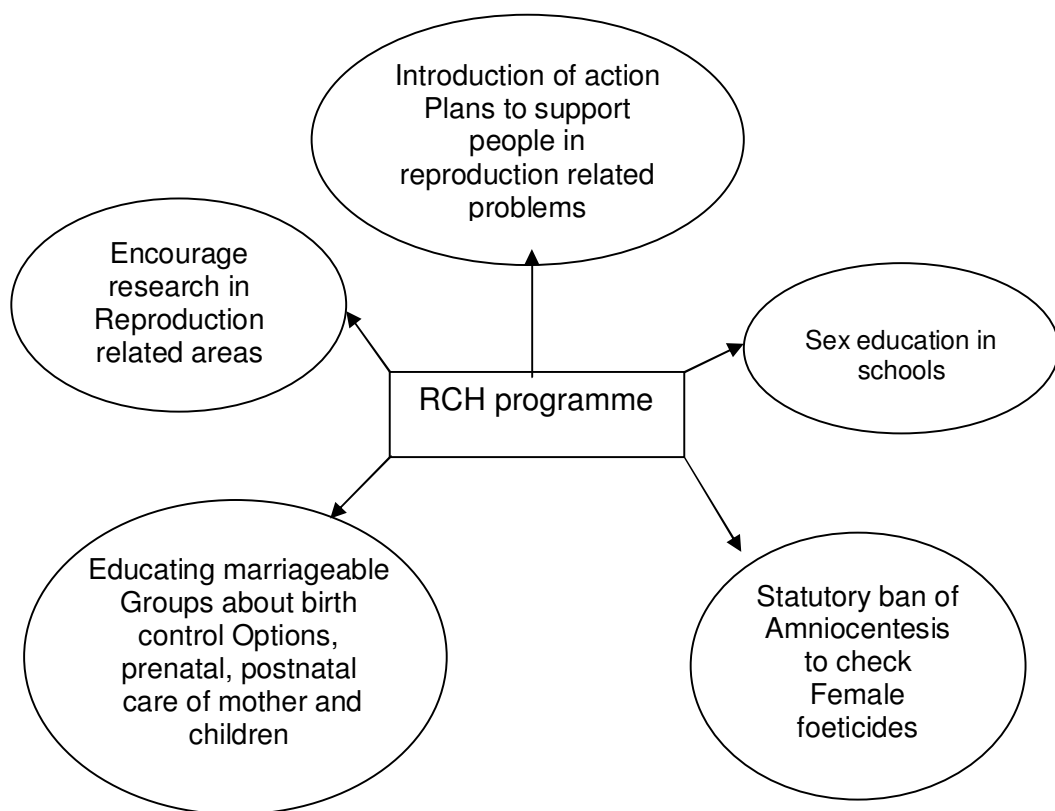

Amniocentesis-	Procedure of diagnosis of foetal cells collected from amniotic fluid to identify chromosomal pattern and disorders of embryo.
Misuse of amniocentesis-	Sex determination of foetus and female foeticide.

Population Explosion and Birth control

Decreased Maternal Mortality Rate (MMR) & Infant Mortality Rate (IMR), Medical facilities, and increase in number of people under reproducible age are the reasons for population explosion.

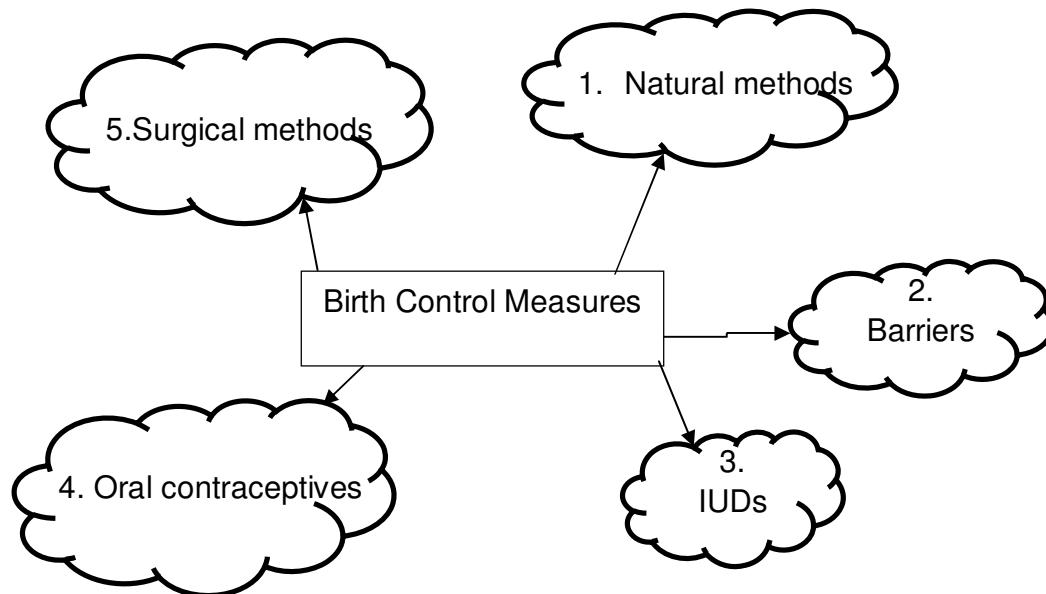
BIRTH CONTROL MEASURES**1. Natural methods**

- **Periodic Abstinence**- Avoid coitus from 10th-17th days of periodic cycle
- **Withdrawal or Coitus interruptus**- Withdrawal of penis before ejaculation.
- **Lactational amenorrhea**- No ovulation during the period of breast-feeding. So chance of pregnancy is low.

Advantages of Natural Methods - No side effect.

Disadvantage-Chances of failure are high.

2. Barriers

- **Condoms** (For males and Females)
- **Vaults, Diaphragms and Cervical caps** (For females)

3. IUDs (Intra Uterine Devices)

IUDs are classified as

- **Non- medicated IUDs** (Eg. Lippes loop)
- **Copper releasing IUDs** (Eg. CuT, Cu7, Multiload 375)
- **Hormone releasing IUDs** (Eg. Progestasert, LNG-20)

How IUDs work?

- IUDs increase phagocytosis of sperms
- Cu ions suppress motility of sperms
- Hormones make uterus unsuitable for implantation

4. Oral contraceptives

Tablets containing hormones like progestogens or progestogen – estrogen combination.

Eg. **Saheli**

5. Injections or Implants

Hormones like Progestogens or progestogen-estrogen combinations can be used in the form of injections or implants

6. Surgical methods

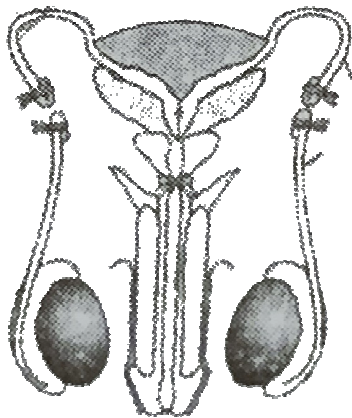

Vasectomy

A small part of vas deference is removed or tied up

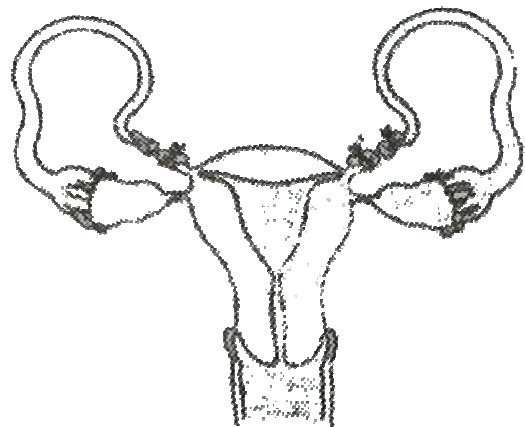

Tubectomy

A small part of oviduct is removed or tied up.

MTP(Medical Termination of Pregnancy)

- Voluntary termination of pregnancy before full term is called MTP.
- MTP is safe during first trimester (up to 12 weeks of pregnancy).
- MTP is legally banned in India to avoid its misuse (Female foeticide is the misuse of MTP).

STD (Sexually Transmitted Diseases) or VD (Venereal Diseases) or RTI (Reproductive Tract Infections)

- Diseases transmitted through sexual intercourse

Examples: Gonorrhoea
Syphilis
Genital Herpes
Genital Warts
Chlamydiasis
Trichomoniasis
Hepatitis B
AIDS

- **Hepatitis B, Genital herpes and HIV infections are not completely curable**

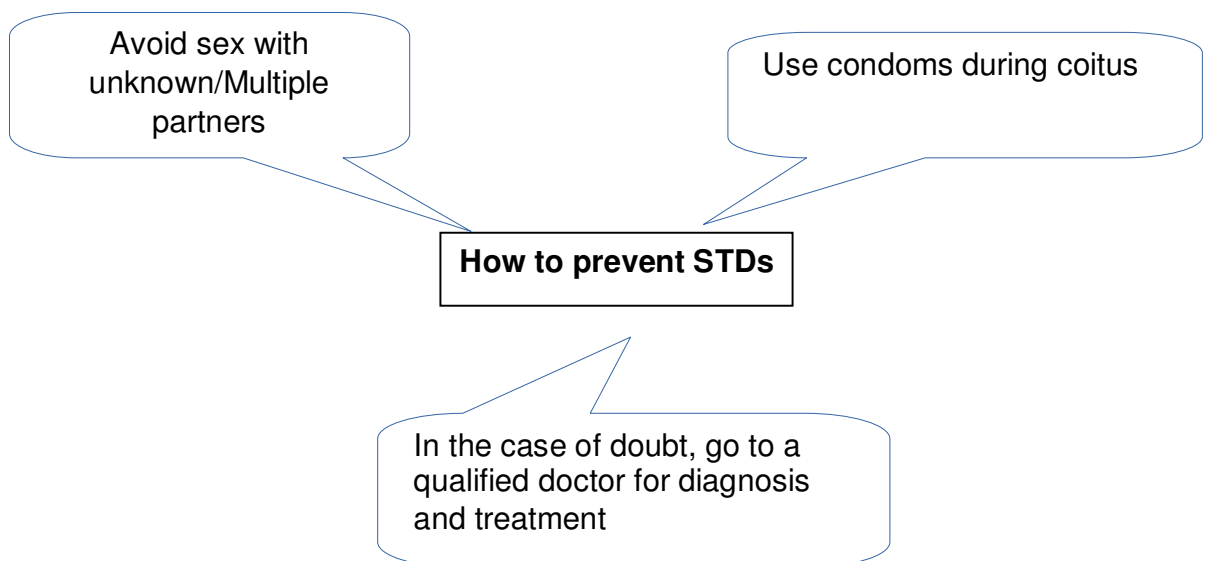

Infertility

- Infertile couples are assisted to have children through special techniques known as ART (Assisted Reproductive Technologies).
- Zygote/Embryo developed by In Vitro fertilisation (IVF) or In Vivo fertilisation can be transferred (Embryo Transfer) to a female body who cannot conceive.
- **IVF (In Vitro Fertilisation)**-Fertilisation takes place outside the body.
In Vivo Fertilisation- Fertilisation takes place within the body of female.

Major Embryo transfer (ET) methods are :

ZIFT (Zygote Intra Fallopian Transfer)

Transfer of embryo (upto 8 blastomeres) into the fallopian tube of a female

IUT (Intra Uterine Transfer)

Transfer of embryo (more than 8 blastomeres) into the uterus.

Some other methods of ART are the following-

GIFT (Gamete Intra Fallopian Transfer)

Ovum is collected from a female and transferred into the fallopian tube of another female who cannot produce ovum but body is suitable for fertilisation and embryonic development.

ICSI (Intra Cytoplasmic Sperm Injection)

In laboratory, sperm is directly injected into the ovum.

If infertility is due to the inability of the male partner to inseminate or due to low sperm count, **Artificial Insemination (AI)** technique is used.

IUI (Intra Uterine Insemination)

It is an AI technique in which semen collected from the husband or a healthy donor is artificially introduced into the vagina or uterus of the female.

CHAPTER 3

PRINCIPLES OF INHERITANCE AND VARIATION

CONTRASTING CHARACTERS STUDIED BY MENDEL

(TABLE OF CONTRASTING CHARACTERS, SEVEN PAIRS)

CHARACTER	DOMINANT TRAIT	RECESSIVE TRAIT
Flower colour	Violet	White
Flower position	Axial	Terminal
Seed colour	Yellow	Green
Seed shape	Round	Wrinkled
Pod shape	Inflated	Constricted
Pod colour	Green	Yellow
Height of plant	Tall	Dwarf/Short

Seven pairs of contrasting characters in Garden Pea.

INHERITANCE OF ONE GENE (Monohybrid cross)**ALLELE**

Different forms of a gene.

Eg: T and t are the alleles of the gene for height

PHENOTYPE

Physical expression of a character or observable character

GENOTYPE

Genetic make up of a character.

INCOMPLETE DOMINANCE

When a dominant allele cannot express completely in heterozygous condition, it is called Incomplete dominance.

In Snapdragon, the red coloured plants (RR) are crossed with the white coloured plants (rr)

The F1 hybrids obtained are pink (Rr) coloured.

When F1 plants were self crossed, F2 plants were in the ratio of

1Red:2Pink;1 White.

Here, phenotypic and genotypic ratios are same

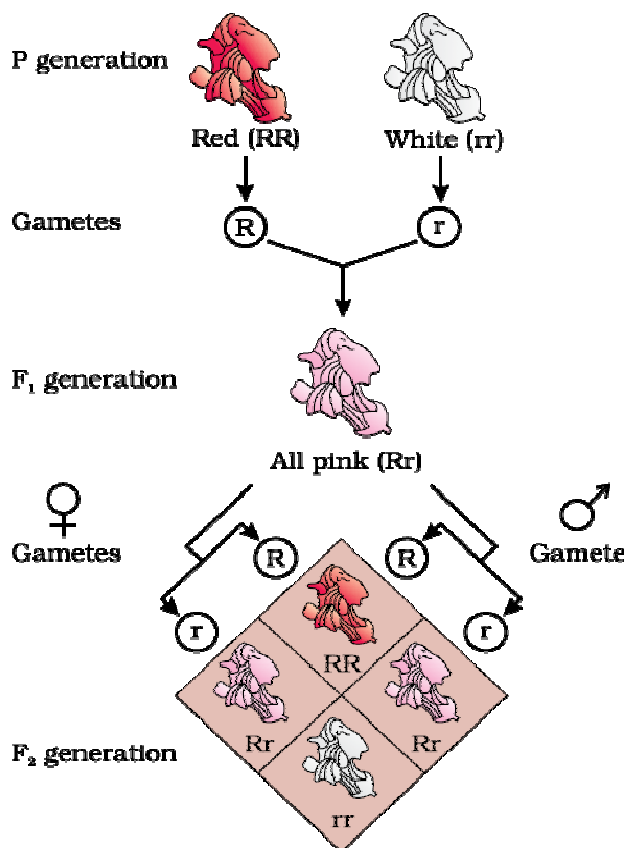

Phenotypic ratio : red : pink : white
1 : 2 : 1

Genotypic ratio : RR : Rr : rr
1 : 2 : 1

CO-DOMINANCE

- In a cross, where F_1 generation resembles both the parents.
- For example-In ABO blood group of man, AB group resembles both the parent.

Allele from Parent 1	Allele from Parent 2	Genotype of offspring	Blood types of offspring
I^A	I^A	$I^A I^A$	A
I^A	I^B	$I^A I^B$	AB
I^A	i	$I^A i$	A
I^B	I^A	$I^A I^B$	AB
I^B	I^B	$I^B I^B$	B
I^B	i	$I^B i$	B
i	i	$i i$	O

Experimental proof for chromosomal theory**Reasons for selecting Drosophila as Experimental material by Morgan:**

1. It is easy to grow Drosophila in synthetic medium.
2. Complete their life cycle with in 3 or 4 weeks.
3. Single mating produce large number of progeny flies.
4. Males and females are easily distinguishable.
5. Hereditary variations can be observed under low power microscope.

SEX DETERMINATION IN HUMANS

- Sex determination mechanism in man is XX-XY type.
- In females, sex chromosome is XX and in male, it is XY
- Male produce two types of sperms- sperms with X chromosome and sperms with Y-chromosome.
- Ovum posses only X chromosomes.
- If sperm with X chromosome fertilises the ovum, zygote develops into female.
- And if sperm with Y chromosome fertilises the ovum, zygote develops into male.

PEDIGREE ANALYSIS

- * An analysis of traits in different generations of a family.
- * It helps to trace the inheritance of a specific trait or abnormalities.
- * Standard symbols used in pedigree analysis are



MENDELIAN DISORDERS

HAEMOPHILIA

- It is a Sex linked recessive inheritance.
- Production of a protein for blood clotting is affected.
- Non- stop bleeding even through simple cut is the symptom .
- Heterozygous carrier female transmit haemophilia to her son.
- Possibility of a female becoming haemophilic is rare because her mother should be atleast a carrier and father should be haemophilic.
- Descendents of Queen Victoria were haemophilic as she also was a carrier

SICKLE CELL ANAEMIA

- It is an autosomal recessive trait.
- Controlled by the genes Hb^A and Hb^S.
- Hb^A Hb^A is normal and Hb^A Hb^S is a carrier
- Homozygous recessive Hb^S Hb^S condition is the disease.
- Substitution of aminoacid Glutamic acid by Valine at the 6th position of the beta globin chain is the reason for sickle cell anaemia.
- It is due to the change of codon from GAG to GUG
- It results in the polymerization of haemoglobin under low oxygen tension.
- So, RBC turns to sickle shape.

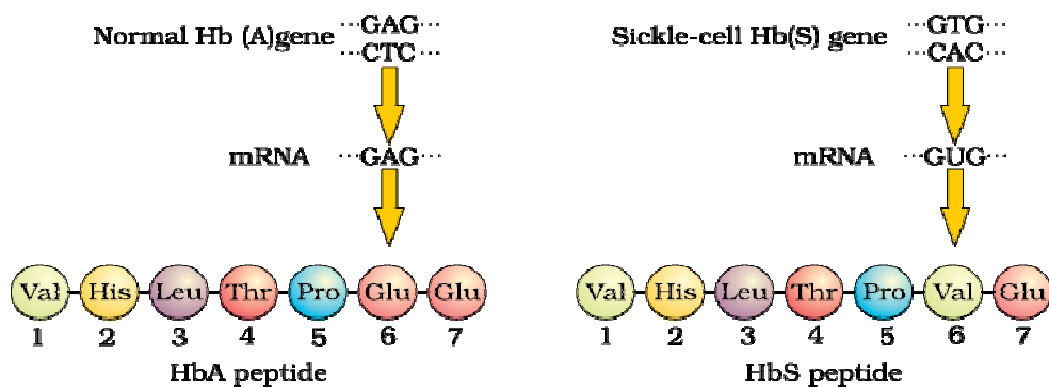
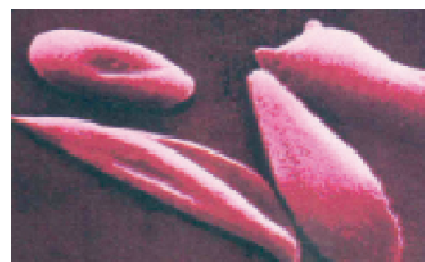

CHROMOSOMAL DISORDERS

**1.DOWN'S
SYNDROME**

- Presence of additional 21st chromosome (Trisomy 21).
- Chromosome number is 47.
- **Characteristic features:** Small round head, furrowed tongue, partially opened mouth , mental retardation, palm crease, congenital heart disease etc.
- First described by Langdon Down

**2.KLINEFELTER'S
SYNDROME**

- Presence of additional X chromosome.
- Chromosome number becomes 47, with karyotype XXY.
- **Characteristic features:** Person has overall Masculine development however feminine charaters will be developed ie. **Gynaecomastia.** (development of breast). Affected person will be sterile.

**3.TURNER'S
SYNDROME**

- Absence of X chromosomes.
- Chromosome number become 45 with X0
- Symptoms: Rudimentary ovary and lacks secondary sexual characters. She will be sterile.

Self Check Questions

1. AB blood group is an example for
2. Make a cross between RR and rr in snapdragon showing F₂ generation.
3. Prove that the genotypic and phenotypic ratios of incomplete dominance is 1:2:1
4. Compare phenotype and genotype.
5. Identify the Syndrome in which gynaecomastia is a characteristic feature.
6. Give examples for chromosomal disorders you have studied.

7. Chance for females to become haemophilic is rare. Do you agree with this statement? Justify your answer.
8. Morgan selected drosophila as experimental material to prove chromosomal theory of inheritance. Why?
9. The chromosome number of both the Klinefelter's and Down's syndrome is 47. Then, how do they differ?
10. Describe the sex determination in man.
11. How do Co-dominance differ from Incomplete dominance?
12. Biconcave disc shape of RBC is changed to sickle shape in sickle-cell anaemia. Why?
13. Mention the Characteristics of Down's syndrome. Why it is known as Trisomy 21?

CHAPTER 4

MOLECULAR BASIS OF INHERITANCE

Study Materials

You have already studied the most famous structure of DNA , the double Helix Model.

Who proposed the Double Helix Structure?

James Watson and Francis Crick.

Now let's discuss the salient features of the Double Helix Structure of DNA.

Salient Features of the double helix structure of DNA

1. It is made of two polypeptide chains. The back bone of the chain is constituted by **sugar-Phosphate**, and the bases project inside.

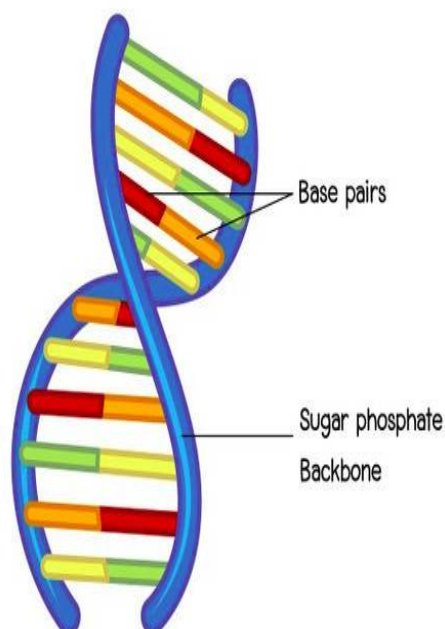

2. The two chains have **antiparallel** polarity. i.e., if one chain has the polarity 5' - 3' the other has 3' - 5'

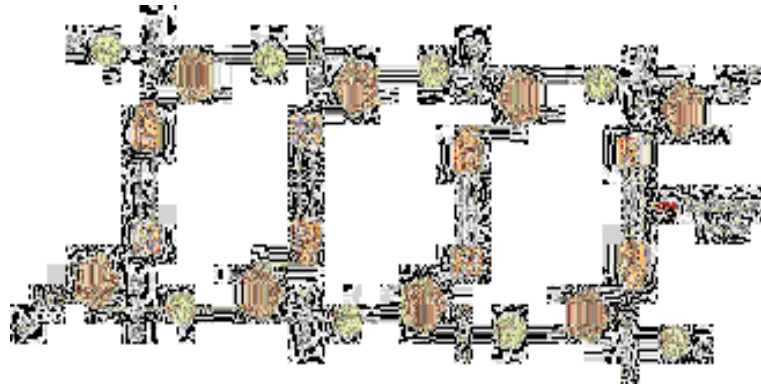

3. The bases in two strands are paired through Hydrogen bonds forming base pairs. Adenine pairs with Thymine through two hydrogen bonds and Guanine pairs with Cytosine through three hydrogen bonds.

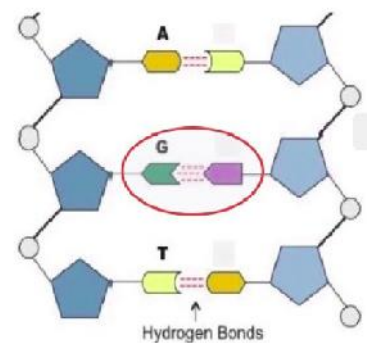

4. The two chains are coiled in a right handed fashion. The pitch of the helix is 3.4 nm (3.4×10^{-9} m). There are roughly 10 base pairs in each turn. The distance between base pairs in a helix is approximately equal to 0.34 nm.

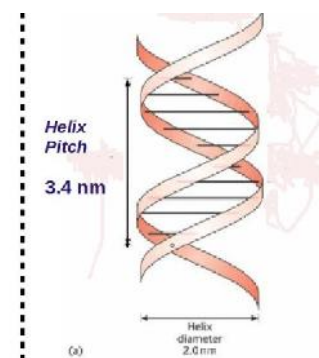

5. The plane of one base pair stacks over the other in a double helix. This confers stability of the Helical structure.



Central Dogma in Molecular Biology

- **Francis Crick** proposed Central Dogma in Molecular Biology
- It explains how the genetic information coded in DNA get revealed or expressed as protein.

“Central dogma in Molecular Biology”



Packaging of DNA helix

- The length of DNA double helix in a typical mammalian cell is estimated approximately as 2.2 metres. Let's see how such a long polymer is packaged in a cell.
- In Eukaryotes, DNA is packed with a set of positively charged basic proteins called histones.
- Histones are organised to form a unit of 8 molecules called **histone Octamer**
- The negatively charged DNA wrapped around the histone octamer and form a structure called **nucleosome**.

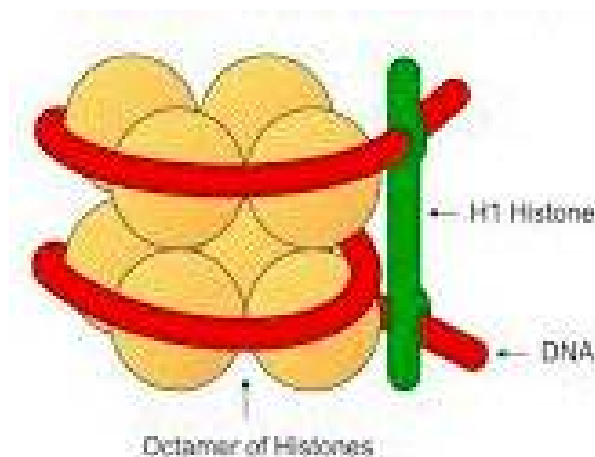

- Nucleosomes constitute the repeating unit of a structure called chromatin.
- Chromatin is present inside the nucleus.
- The nucleosomes in chromatin are seen as **beads-on-string** when viewed under EM (Electron Microscope).
- Chromatin has two regions : **Euchromatin & Heterochromatin**

Euchromatin

- Loosely Packed
- Lightly Stained
- Transcriptionally active

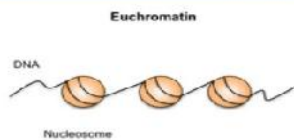

Heterochromatin

- **Densely packed**
- **Darkly stained**
- **Transcriptionally inactive**

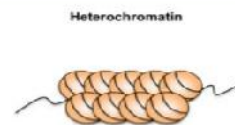

Griffith's Transformation experiment

- In 1928, Frederick Griffith conducted a series of experiments with *Streptococcus pneumoniae* and proposed **Transforming principle**.



Frederich Griffith

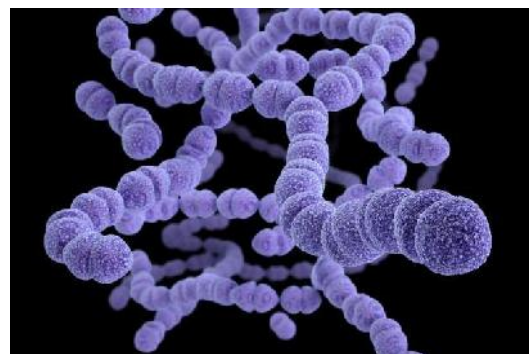

Streptococcus pneumoniae

- There are two strains of Streptococcus bacteria such as **S strain** bacteria and **R strain** bacteria

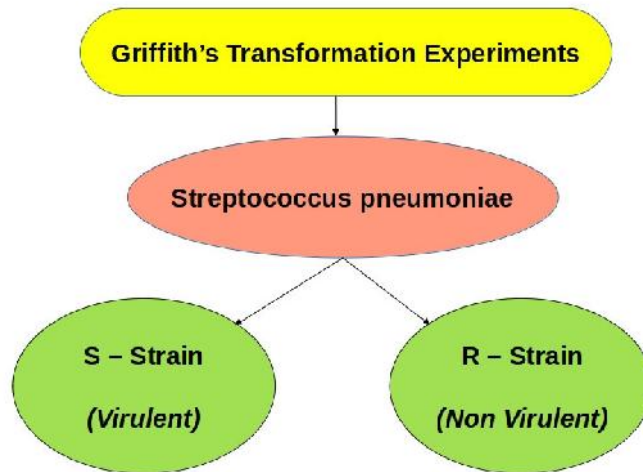

- **S strain bacteria** possess a mucous (polysaccharide) coat . It **causes pneumonia** in animals, hence it is the virulent form.
- **R strain bacteria** does not possess mucous coat. It is **not able to cause pneumonia** and hence it is the non-virulent form.

Summary of his Experiment

S Strain —————> inject into Mice —————> Mice die

R Strain —————> Inject into Mice —————> Mice Live

Griffith prepared Heat killed S strain bacteria and injected in to the mice.

Mice remained alive.

S Strain (heat killed) —————> inject into Mice —————> Mice live

When he injected a mixture of heat killed S and live R bacteria the mice died.

S Strain (heat killed) + R strain (live) —————> inject into Mice —————> Mice died

He observed living S strain bacteria from the dead mice.

Conclusion

- He concluded that the R strain bacteria had somehow been transformed by the heat killed S strain bacteria

Some transforming principle transferred from the heat killed S Strain, had enabled the R Strain to synthesise a smooth polysaccharide coat and made it virulent.

- This must be due to the transfer of genetic material from heat killed S strain to R strain.

Hershey and Chase Experiment

- In 1952, Alfred Hershey and Martha Chase proved that DNA is the genetic Material of bacteriophage.
- They Worked with bacteriophages (viruses that attack bacteria).
- When a virus attacks bacterium the genetic material of virus enters the bacterial cell. Virus multiplies in bacterial cell.
- Hershey and Chase worked to discover whether the protein coat or DNA of the virus enters the bacterial cell.

Experiment

They grew some viruses in a radio active medium of **Phosphorus (^{32}P)** and some others in radioactive **Sulphur (^{35}S)** medium

- Viruses grown in **radioactive phosphorus** medium have **radioactive DNA**.
- Viruses grown in **radioactive Sulphur** medium have **radioactive proteins**.
- These radioactive phages were allowed to attack E.coli bacteria (It is called **Infection**) separately.
- During infection, genetic material of the virus enters the bacteria.
- After infection, the viral protein coats were removed from the bacteria by a process called **blending**.
- The virus particles were separated from the bacteria by spinning them in a centrifuge and the process is called **centrifugation**.

Observation

- Bacteria which were infected with **radioactive protein** were **not radioactive**

- But the bacteria which were infected with **radioactive DNA** were **radioactive**. It proved that DNA was the genetic material that passed from the virus to bacteria.

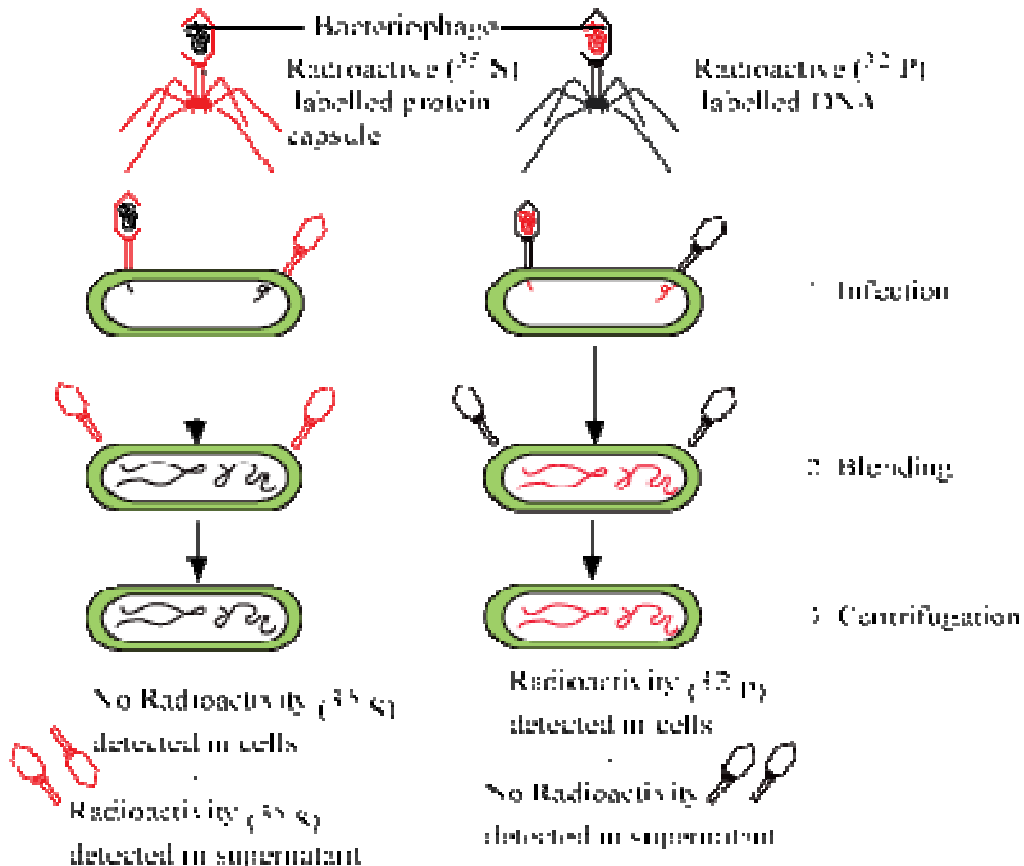

Diagram showing Hershey – Chase Experimental steps

REPLICATION

- The Machinery and enzymes for DNA Replication

The main enzyme for DNA Replication is **DNA dependent DNA polymerase**

- DNA dependent DNA Polymerase

These enzymes catalyse the polymerisation of large number of nucleotides in a very short time.

Replication Fork

- DNA replication starts within a small opening of the DNA helix known as **replication fork**

Leading strand

- The DNA dependent DNA polymerase catalyses polymerisation in 5' - 3' direction only,
- On one strand (ie, the template with polarity 3' - 5'), the replication is continuous. Here the new strand is known as the **leading strand or Continuous strand**.

Lagging strand

- On the other strand (template with polarity 5' - 3'), the replication is discontinuous. Here the new strand is called **lagging strand or discontinuous strand**.
- Discontinuously synthesised DNA fragments are called okazaki fragments

DNA Ligase

- Discontinuously synthesised DNA fragments are joined by the enzyme **DNA ligase**

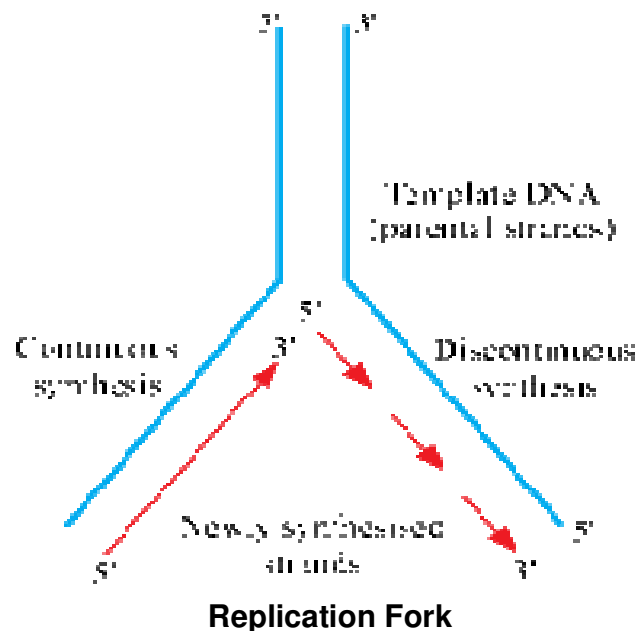

Transcription Unit

- A transcription unit is the region of DNA used for the formation of RNA
- A transcription unit has three regions
 1. A Promoter
 2. The Structural gene
 3. A Terminator

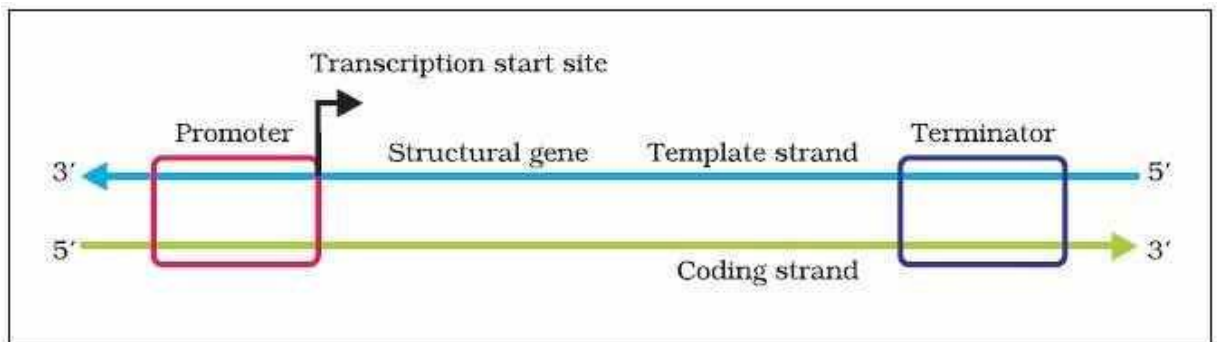

Figure 6.9 Schematic structure of a transcription unit

- The strand that has the polarity 3' - 5' acts as a template, and is referred to as a **template strand**
- The other strand which has the polarity 5' - 3' and the sequence same as RNA is referred to as **coding strand**

Promoter

- Promoter is a DNA sequence that provides binding site for RNA polymerase for initiation of transcription.
- It is located towards the 5' (upstream) end of the structural gene.

Terminator

- The terminator is located towards 3' end (downstream) of the structural gene.
- It usually defines the end of the process of transcription.

Transcription Unit and the gene

- **Cistron**-Cistron is a segment of DNA coding for a polypeptide

Monocistronic Unit

- The structural gene in the transcription unit of eukaryotes are monocistronic.
- Monocistronic structural genes have interrupted coding sequences. ie., the genes are split or the genes with coding sequences are interrupted by the genes with non-coding sequences.

Exons

- The coding sequences or expressed sequences of cistron are called **exons**.

Introns

- The non - coding sequences of cistrons are called **introns** or intervening sequence. They do not appear in the mature or processed RNA

Polycistronic unit

- The structural gene in the transcription unit of bacteria or prokaryotes is polycistronic.

The salient features of genetic code

- **The codon is a triplet.** 61 codons code for aminoacids and 3 codons do not code for any aminoacids, hence they function as stop codons
- One codon codes for one amino acid, hence genetic code is **unambiguous** and **specific**
- Some amino acids are coded by more than one codon, hence the code is **degenerate**
- The codon is read in mRNA in a contiguous fashion. There are no punctuations.
- The code is nearly universal. But there are certain exceptions.
- AUG has dual functions. It codes for Methionine (Met) and it also acts as initiator codon.

The Lac Operon

- **Lactose** is the substrate for the enzyme beta – galactosidase and it regulates switching on and off of the operon. Hence it is termed as **inducer**.

Components of lac Operon

- **Regulatory gene (i gene)** - It produces repressor proteins
- **Promoter gene (P)** - It is the region where RNA polymerase binds
- **Structural gene (z, y, a)** - Structural gene transcribe into lac mRNA and it is translated into lac proteins.

Cistron 'z' codes for **beta- galactosidase** (enzyme which converts lactose into galactose and glucose)

Cistron 'y' codes for **permease** (which increases the permeability of the cell to Beta- galactosidase)

Cistron 'a' codes for **transacetylase**

lac Operon (In absence of Inducer)

- Regulatory gene transcribes into repressor mRNA
- Repressor mRNA translates into repressor protein.
- Repressor protein binds to the operator region
- This binding prevents the RNA polymerase from transcription of gene.

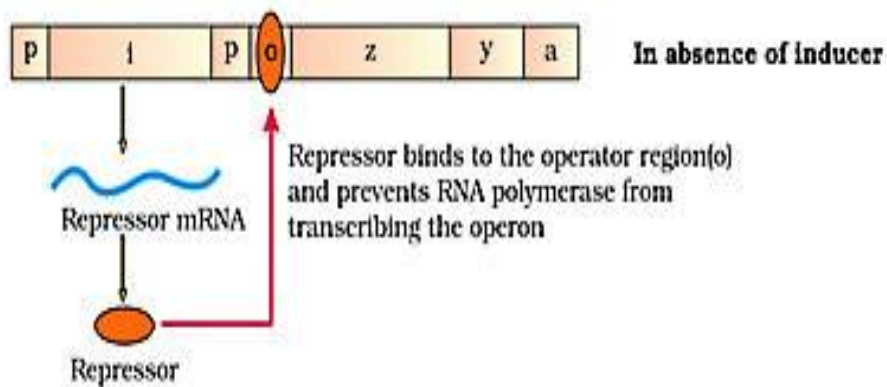

lac operon (In presence of inducer)

- Regulatory gene transcribes into repressor mRNA
- Repressor mRNA translates into repressor protein.
- Inducer such as lactose binds with repressor protein
- Inactive repressor could not bind to operator.
- RNA polymerase transcribes operon.

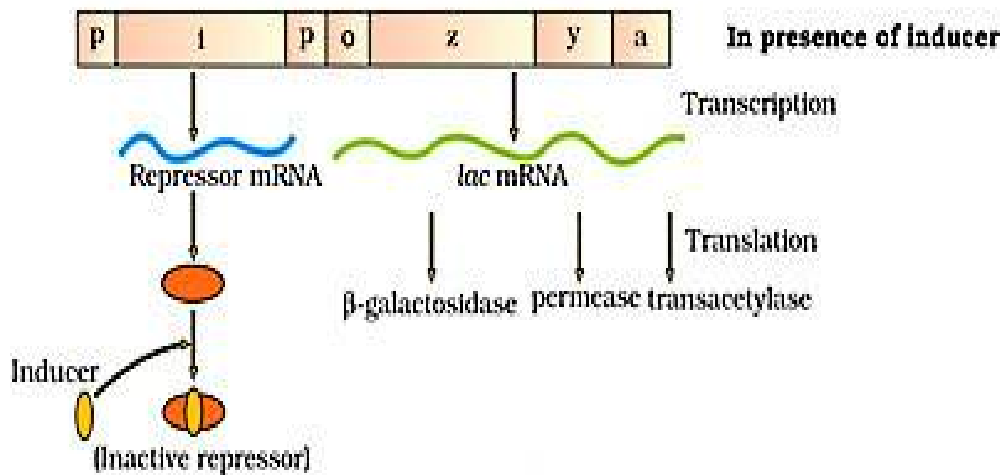

Human Genome project

- Human Genome Project was the first mega project for the sequencing of nucleotides and mapping of all the genes in human genome

HGP = Human Genome Project

BAC = Bacterial Artificial Chromosomes

YAC = Yeast Artificial Chromosomes

DNA FINGERPRINTING

Steps in DNA fingerprinting

1. Isolation of DNA
2. Digestion of DNA by restriction endonucleases
3. Separation of DNA fragments by electrophoresis
4. Transferring (blotting) of separated DNA fragments to synthetic membranes , such as nitrocellulose or nylon
5. Hybridisation using labelled VNTR probe.
6. Detection of hybridised DNA fragments by autoradiography.

Application of DNA fingerprinting

- DNA finger printing has forensic applications.
- It is used as a powerful tool to solve the problems of paternity, rape, murder etc.
- It is used in determining population diversities and genetic diversities.

CHAPTER 5

EVOLUTION

ORIGIN OF LIFE

- In 1953, S L MILLER created similar conditions of primitive earth in his laboratory.
- He recreated conditions of primitive earth in laboratory.
- It is to prove that, organic molecules like amino acids, glucose, etc. formed from inorganic molecules like CH_4 , NH_3 , H_2 etc .
- In his lab, he observed the formation of amino acids and other organic molecules.
- So he concluded that, in primitive earth, organic compounds were formed from inorganic molecules.
- From these organic molecules, life originated in primitive earth.

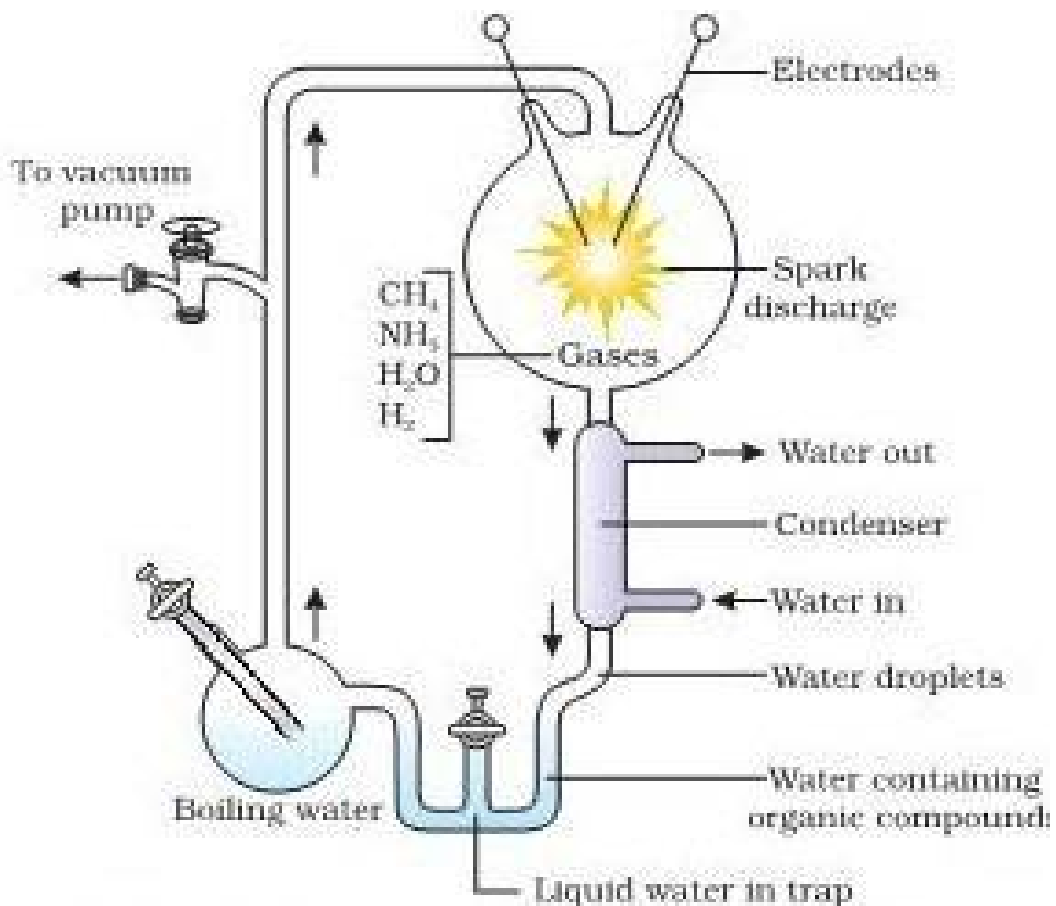

EVIDENCES OF EVOLUTION

Study of **homologous and analogous organs** reveals the **anatomical and morphological evidences** of evolution.

HOMOLOGOUS ORGANS	ANALOGOUS ORGANS
<ul style="list-style-type: none"> Organs with same structure and perform different functions 	<ul style="list-style-type: none"> Organs with different structure and perform same functions
<ul style="list-style-type: none"> Homology is due to divergent evolution. 	<ul style="list-style-type: none"> Analogy due to convergent evolution.
<ul style="list-style-type: none"> Ex. (1) Fore limbs of Man, Cheetah, Whale and Bat have same pattern of bones and perform different functions. (2) Hearts of vertebrates (3) Brains of Vertebrates (4) Thorns and tendrils of Bougainvilla and Cucurbita. 	<ul style="list-style-type: none"> Ex. (1) Wings of Butterfly and Bird have different anatomy and perform same function. (2) Eyes of Octopus and Mammals. (3) Flippers of Penguin and Dolphins (4) Root modification of sweet potato and stem modification of potato

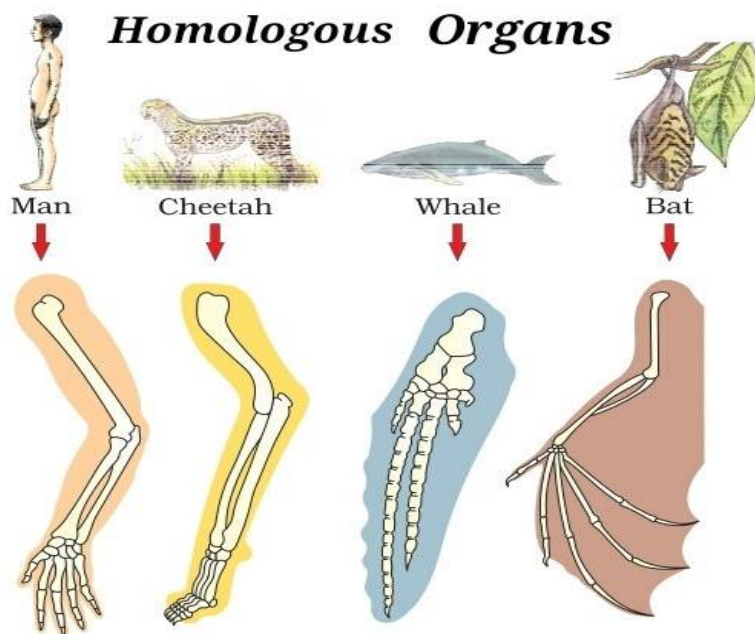

EVOLUTION BY NATURAL SELECTION

- An interesting observation supporting Evolution by Natural Selection comes from England.
- In 1850s, before industrialisation in England, white winged moth survived from the predators due the presence of lichens on trees. So there were more white winged moths than dark winged moths.
- But after industrialization, due to pollution, Predators spot white winged moths against its contrasting background and picked out.
- Thus in 1920, number of dark winged moths increased more.

HARDY-WEINBERG EQUILIBRIUM

Hardy Weinberg principle states that allelic frequencies in a population remains stable and constant from generation to generation. It is genetic equilibrium.

Sum total of all the allelic frequencies is 1

Equation for Hardy Weinberg principle is

$$P^2 + 2pq + q^2 = 1$$

Here, 'p' and 'q' represents the allelic frequencies of 'A' (dominant allele) and 'a' (recessive allele) in a population.

Then, allele frequency of AA individuals = p^2

Aa individuals = $2pq$

aa individuals = q^2

Total gene frequency of a population = 1

Factors affecting Hardy Weinberg principle

<p>1. GENE MIGRATION</p> <p>Genes are added or lost from the population.</p>	<p>2. GENETIC DRIFT</p> <p>Random changes occurs by chance.</p>	<p>3. MUTATION</p> <p>Sudden heritable changes leads to speciation.</p>
<p>4. GENETIC RECOMBINATION</p> <p>Rearrangement or reshuffling of genes.</p>	<p>5. NATURAL SELECTION</p> <p>Nature selects organisms with favourable variations.</p>	

ORIGIN AND EVOLUTION OF MAN

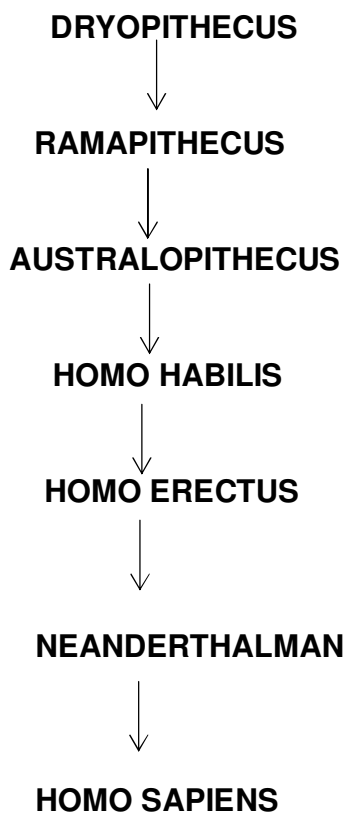

EVOLUTION

1. Define Hardy - Weinberg principle with equation.
2. Can you suggest the factors affecting Hardy-Weinberg principle.
3. How industrialisation in England affect the population of moths?
4. How Miller recreated the primitive earth's condition in his laboratory?
5. Compare Homologous and Analogous organs.
6. Can you construct a flow chart showing evolution of man.
7. Classify the following examples in appropriate headings.

Wings of butterfly and bird, flippers of Penguins and Dolphins,

Hearts of vertebrates, Eyes of Octopus and Mammals,

Thorns and Tendrils of Bougainvillea, Sweet potato and Potato,

Brains of vertebrates.

8. Write the Principle related to the equation $p^2+2pq+q^2=1$.

What are the factors affecting this principle

9. Comment on this picture.

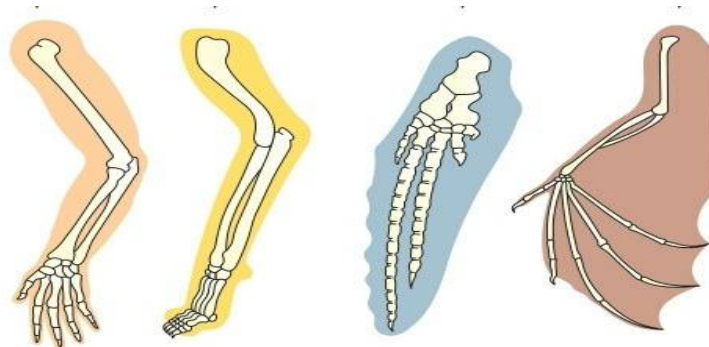

Chapter 6

HUMAN HEALTH AND DISEASE

COMMON DISEASES IN MAN

TYPHOID

- Bacterial disease
- Caused by **Salmonella typhi**
- Through contaminated water and food, bacteria enters the small intestine and migrate to other parts.
- Symptoms are high fever, weakness, stomach pain, constipation, headache, loss of appetite.
- In severe conditions, perforations are formed in intestine.
- Typhoid fever is confirmed by **WIDAL TEST**.

MALARIA

- Caused by a protozoan, **Plasmodium**.
- Plasmodium requires two hosts- Man and female Anopheles mosquito.
- MOSQUITO is the vector.
- Plasmodium enters the body as Sporozoites by the bite of mosquito.
- Plasmodium multiplies in the liver and then attacks the RBCs.
- With in 3 or 4 days, RBC ruptures and release sporozoites along with a toxic substance, which cause fever.
- After biting, the sporozoites enters the mosquito's salivary gland.

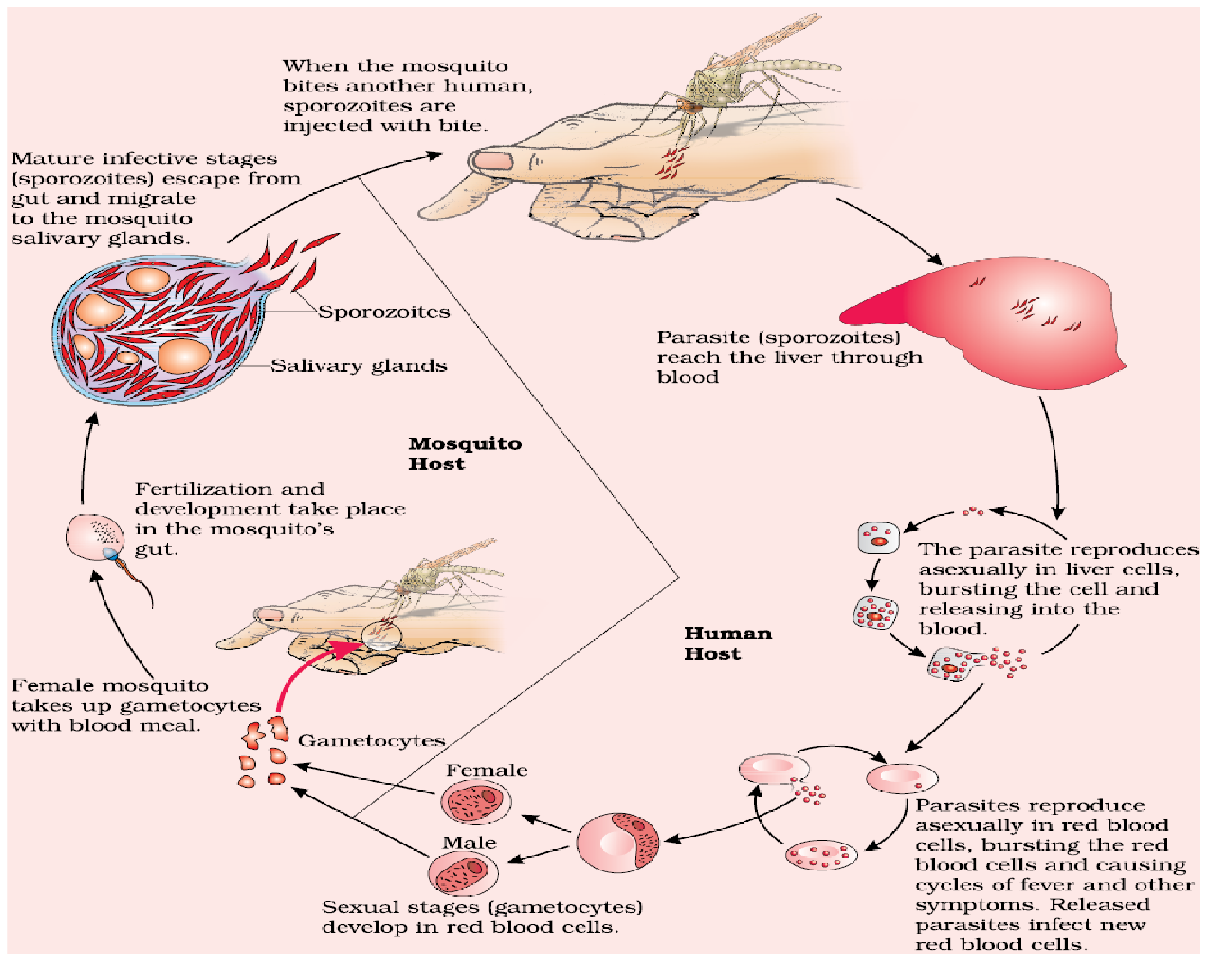

INNATE IMMUNITY (Non-specific immunity present at birth.)

- Four types of barriers in innate immunity.

1. PHYSICAL BARRIER	Skin and mucus coating in respiratory, gastro intestinal tract, urinogenital tract prevents the entry of pathogens.
2. PHYSIOLOGICAL BARRIER	Acid in stomach, saliva in mouth and tear from eyes also destroy pathogens.
3. CELLULAR BARRIER	Polymorpho nuclear leucocytes (PNML or neutrophil) Monocytes and lymphocytes, phagocytose (engulf) the germs
4. CYTOKINE BARRIER	Interferons produced by virus-infected cells to protect non infected cells.

Acquired immunity

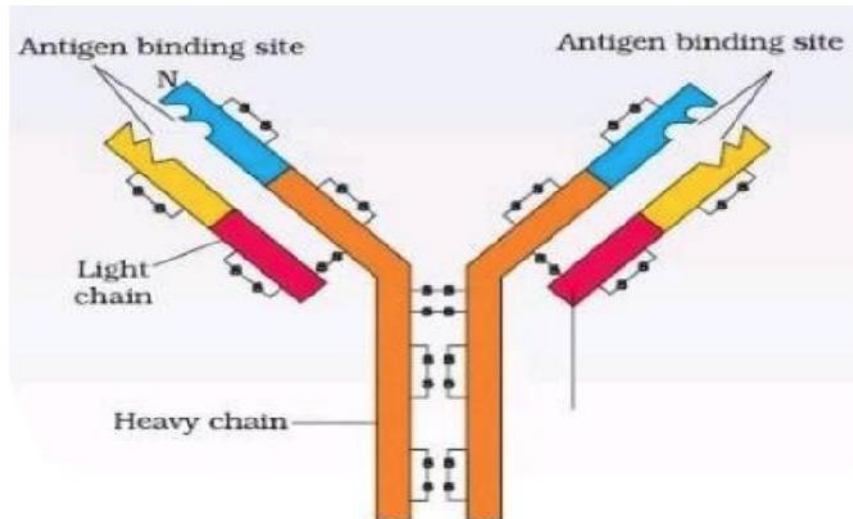

Acquired immunity is carried out by B lymphocytes and T lymphocytes. B lymphocytes produce **antibody** to destroy pathogen.

AIDS

Acquired Immuno Deficiency Syndrome (AIDS) caused by Human Immuno Virus (HIV).

TRANSMISSION

1. Sexual contact with infected persons.
2. By transfusion of contaminated blood.
3. By sharing infected needles.
- 4 .From infected mother to her child through placenta.

TEST FOR AIDS

ELISA (Enzyme linked immuno sorbent assay) is the widely used test.

PREVENTION OF AIDS

- Educate people about AIDS by NACO and non governmental organizations (NGO).
- Making blood safe from HIV.
- Ensuring the use of only disposable needles and syringes.
- Use barriers like condoms during coitus.
- Controlling drug abuse to prevent the sharing of needles.
- Advocating safe sex.
- Promoting regular checkups for HIV in susceptible populations.

CANCER

In our body, uncontrolled cell division leads to **two** types of tumors.

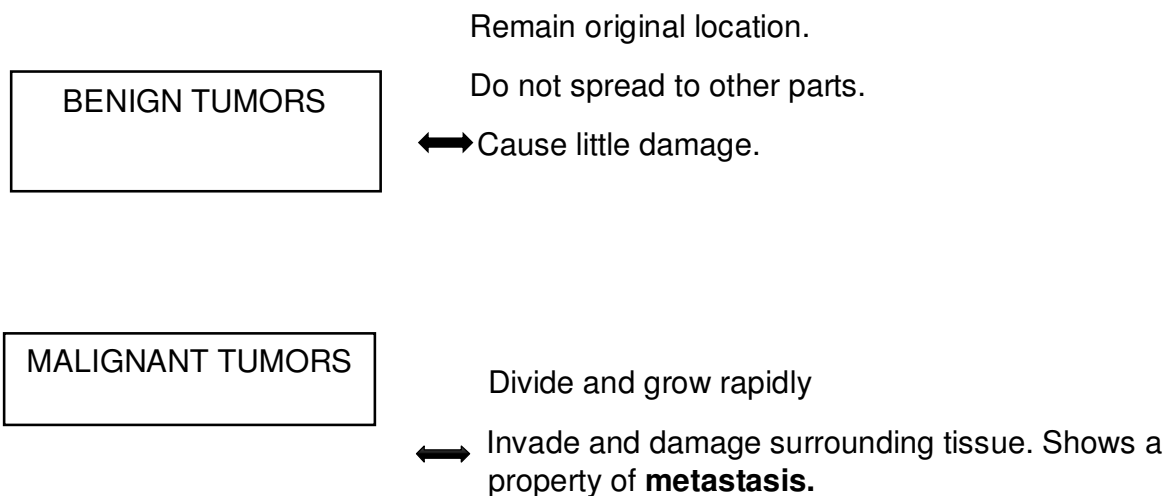

Metastasis

Cells separate from tumors and reach distant places through blood. They start new tumor there.

TREATMENT OF CANCER

Cancer Treatment includes,

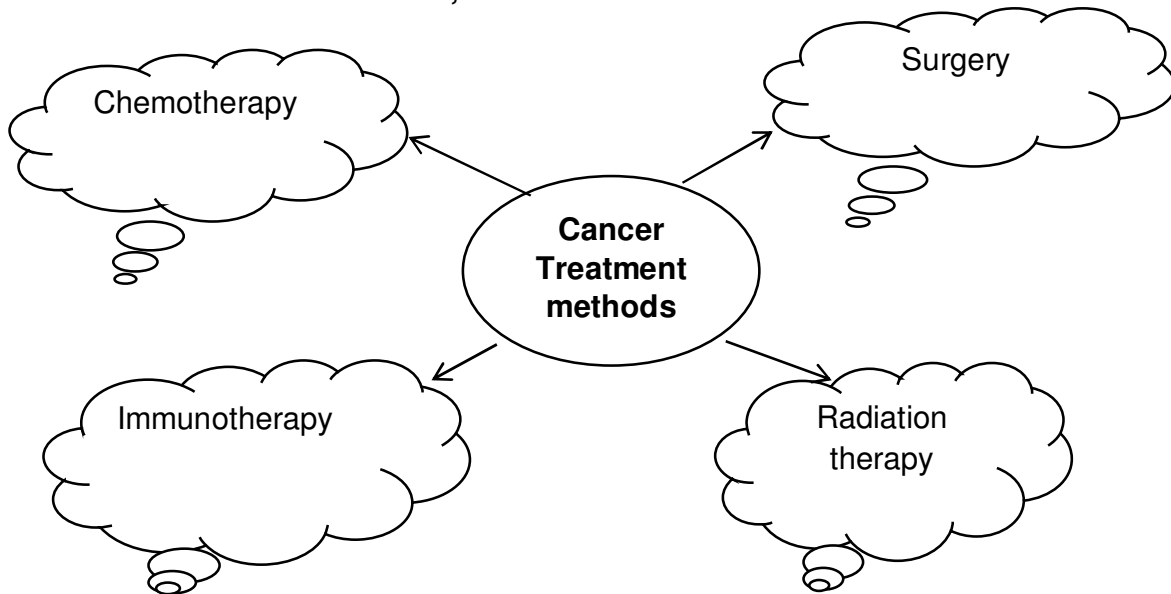

Effects of drug/Alcohol abuse

- Immediate effects are reckless behaviour, vandalism and violence.
- Excess dose may lead to coma and death due to respiratory failure, heart failure or cerebral hemorrhage.
- Youth shows warning signs like lack of interest in personal hygiene, drop in academic performance, isolation, depression, fatigue, aggressive and rebellious behaviour, etc.
- Drug abuser may turn to stealing for getting essential money.
- Intravenous injection of drugs may cause infections like AIDS, Hepatitis B, etc.
- Long term alcohol abuse leads to damages in nervous system and liver cirrhosis.
- Misuse of drugs by sports persons cause severe health problems, development of male characters in females and female characters in males.

Self check questions

1. a) Identify the disease from the following symptoms.
 - High fever
 - Weakness
 - Stomach pain
 - Constipation
 - Headache
 - Loss of appetiteb) Write the confirmation test of this disease.
c) How this disease is transmitted?
d) Name the causative organism.
2. Malaria is a protozoan disease caused by
3. 'Innate immunity is a type of Non-specific immunity'. Write various type of barriers providing Innate immunity .
4. a)What is AIDS? How it is transmitted?
b) Name the causative organism of AIDS.
c) Write the ways to prevent AIDS.
5. a. Differentiate Benign tumor from Malignant tumor
b. Which of the above tumor is cancerous?
c. Mention various methods for the treatment of cancer.
6. Write any four ill-effects due to drug/alcohol abuse.

CHAPTER 7

MICROBES IN HUMAN WELFARE

Some examples for uses of microbes are given below

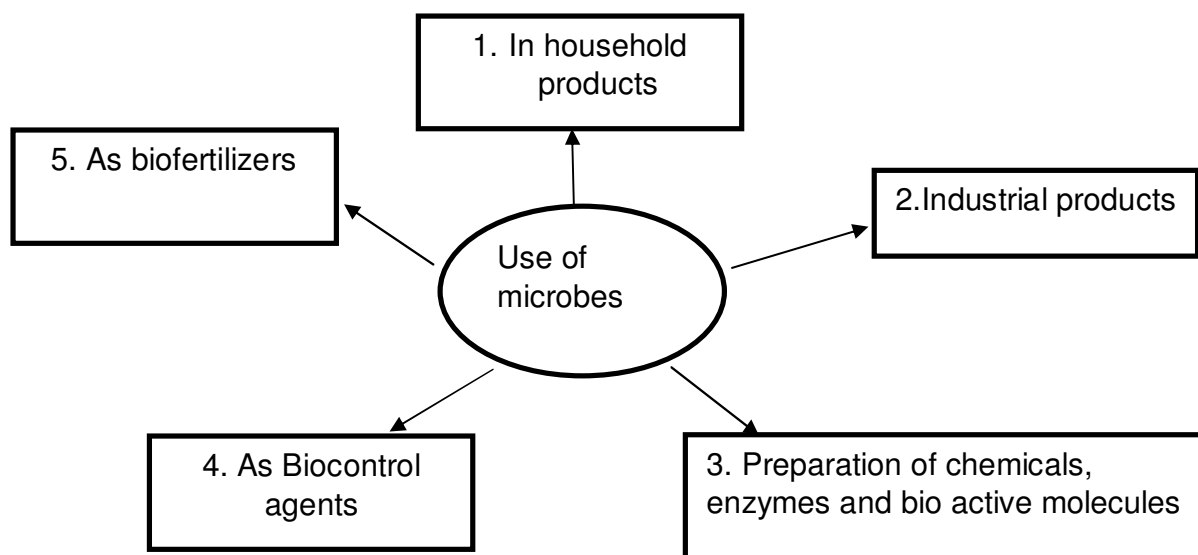

1. Microbes in the production of household products

Eg. Lactic acid Bacteria (LAB) or Lactobacillus converts milk into curd. Curd contains vitamin B₁₂.

2.a. Microbes in the production of chemicals

Chemical	Microbe	Type of organism
Citric acid	Aspergillus niger	Fungus
Acetic acid	Acetobacter aceti	Bacterium
Butyric acid	Clostridium butylicum	Bacterium
Lactic acid	Lactobacillus	Bacterium
Ethanol	Saccharomyces cerevisiae	Yeast

2.a. Microbes in the production of enzymes

Enzymes	Microbe	Uses of enzymes
Lipase	-	In detergents to remove oily stains from laundry
Pectinase	-	Clarifies bottled juice
Protease	-	Clarifies bottled juice
Streptokinase	Streptococcus	Removes clots from blood vessels

2. c. Microbes in the production of bioactive molecules

Bioactive molecules	Microbe	Uses of bioactive molecules
Cyclosporin A	Trichoderma polysporum	As immunosuppressive agent during organ transplantation
Statin	Monascus purpureus	Blood-cholesterol lowering agent

2. Microbes as biocontrol agents

Microbe	Uses
Bacillus thuringiensis	Control butterfly caterpillars
Trichoderma polysporum (a free living fungus)	Protects plants from pathogens and diseases

CHAPTER 8 BIODIVERSITY AND CONSERVATION

SPECIES - AREA RELATION

- Alexander von Humboldt observed that species richness increased with increased explored area.

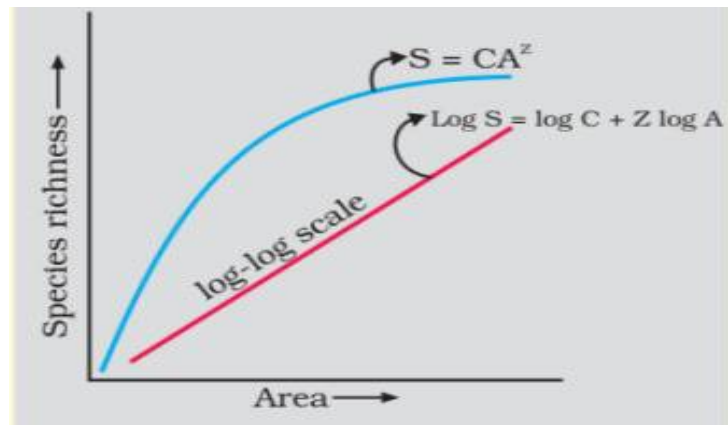

- This graph shows the species - area relation as a rectangular hyperbola and describes the equation as

$$S = CA^z$$

- On logarithmic scale, the relationship is a straight line and describes the equation as.

$$\log S = \log C + Z \log A$$

- Where S = Species richness
 A = Area
 Z = Slope of the line (value range from **0.1 to 0.2**)
 C = Y- intercept

In larger areas like continents, Z value increases from **0.6 to 1.2**

**IMPORTANCE OF SPECIES DIVERSITY TO THE ECOSYSTEM
(RIVET POPPER HYPOTHESIS)**

- Each and every species is important for the survival of other species in an ecosystem.
- **Paul Ehrlich** compared, ecosystem as an **aeroplane** and species as **rivets**.
- All the parts of an aeroplane are joined together using thousands of rivets.
- Removal of the rivets cause danger to the aeroplane.
- Thus loss of species from the ecosystem cause extinction of species and also affect the key functioning of ecosystem.

CAUSES OF BIODIVERSITY LOSS

Major **four** causes of Biodiversity loss are called “The Evil Quartet”

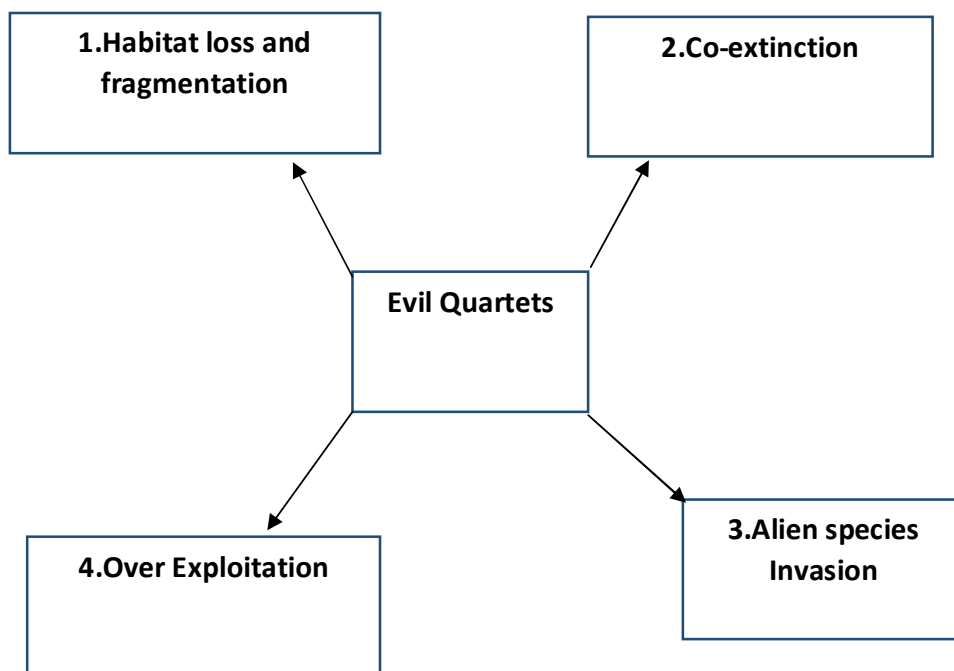

- **Habitat loss and Fragmentation**
Habitat of organisms lost by human activities.
Large habitats also break into small fragments which leads to the loss of habitat.

- **Over Exploitation**

Man always depend on nature for food and shelter.

When needs turns to greed, it cause extinction of species.

- **Alien species Invasion**

Introduction of alien species leads to the extinction of indigenous species.

Example;

Introduction of Nile Perch into the Lake Victoria causes the extinction of more than 200 species of Cichlid fish in the lake.

- **Co-extinction**

Extinction of one species leads to the extinction of other species which depends on it.

HOW DO WE CONSERVE BIODIVERSITY

We can conserve biodiversity by **two** methods.

BIODIVERSITY CONSERVATION

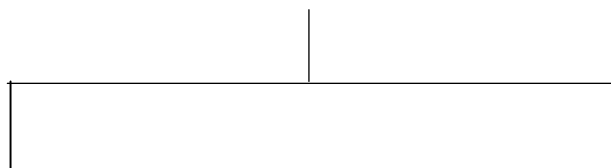

Insitu conservation

Species are protected with its natural habitat by legal or cultural measures.

Eg: Hot spots, Biosphere reserves, National parks, Sanctuaries, Sacred groves etc.

Exsitu conservation

Threatened species are taken from their natural habitat and protected in special settings.

Eg: Zoological park, Botanical garden ,Safari parks, Seed banks, Cryopreservation of gametes etc.

BIODIVERSITY AND CONSERVATION

1. In the equation, $\log S = \log C + Z \log A$. write the terms S,C,Z and A represent ?
2. Write the Z value considering large continents in Species-Area relationship.
3. Analyse the term 'The Evil Quartet'.
4. Mention the causes for biodiversity losses.
5. How do we can conserve our biodiversity?
6. Select from the following which belongs to Insitu conservation.
Sacred groves, Zoological parks, Seed bank, Sanctuaries, National parks, Hotspots, Cryopreservation of gametes, Biosphere reserves
7. Can you explain Rivet Popper hypothesis?
8. Rivet Popper hypothesis is proposed by
9. The graph of Species-Area relationship is constructed by.....

GENERAL EDUCATION DEPARTMENT

SAMAGRA SHIKSHA KERALA