

## Section A

This question consists of TWENTY FIVE sub-questions (1.1-1.25) of ONE mark each. For each of these sub-questions, four choices (A, B, C and D) are given, out of which only one is correct. Answer each sub-question by darkening the appropriate bubble on the OBJECTIVE RESPONSE SHEET (ORS) using a soft HB pencil. Do not use the ORS for any rough work. You may like to use the answer book for any rough work, if needed.

**Q.1.1** A current impulse,  $5\delta(t)$ , is forced through a capacitor  $C$ . The voltage,  $v_c(t)$ , across the capacitor is given by

- (A)  $5t$  (B)  $5u(t) - C$   
 (C)  $\frac{5}{C}t$  (D)  $\frac{5u(t)}{C}$

**Q.1.2** Fourier Series for the waveform,  $f(t)$  shown in Figure is

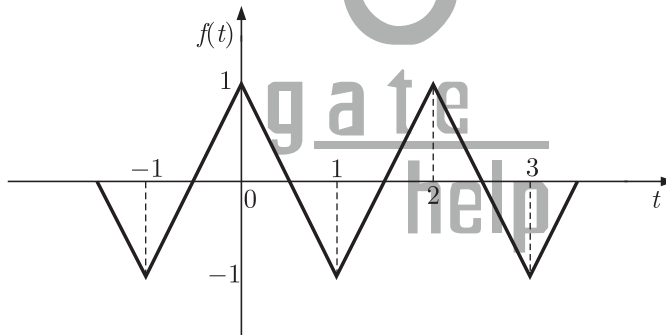

- (A)  $\frac{8}{\pi^2} \left[ \sin(\pi t) + \frac{1}{9} \sin(3\pi t) + \frac{1}{25} \sin(5\pi t) + \dots \right]$   
 (B)  $\frac{8}{\pi^2} \left[ \sin(\pi t) - \frac{1}{9} \cos(3\pi t) + \frac{1}{25} \sin(5\pi t) + \dots \right]$   
 (C)  $\frac{8}{\pi^2} \left[ \cos(\pi t) + \frac{1}{9} \cos(3\pi t) + \frac{1}{25} \cos(5\pi t) + \dots \right]$   
 (D)  $\frac{8}{\pi^2} \left[ \cos(\pi t) - \frac{1}{9} \sin(3\pi t) + \frac{1}{25} \sin(5\pi t) + \dots \right]$

**Q.1.3** The graph of an electrical network has  $N$  nodes and  $B$  branches. The number of links  $L$ , with respect to the choice of a tree, is given by

- (A)  $B - N + 1$  (B)  $B + N$

(C)  $N - B + 1$

(D)  $N - 2B - 1$

**Q.1.4** Two in-phase, 50 Hz sinusoidal waveforms of unit amplitude are fed into channel-1 and channel-2 respectively of an oscilloscope. Assuming that the voltage scale, time scale and other settings are exactly the same for both the channels, what would be observed if the oscilloscope is operated in X-Y mode ?

(A) A circle of unit radius

(B) An ellipse

(C) A parabola

(D) A straight line inclined at  $45^\circ$  with respect to the x-axis.

**Q.1.5** Given a vector field  $\vec{F}$ , the divergence theorem states that

(A)  $\int_S \vec{F} \cdot d\vec{S} = \int_V \vec{\nabla} \cdot \vec{F} dV$

(B)  $\int_S \vec{F} \cdot d\vec{S} = \int_V \vec{\nabla} \times \vec{F} dV$

(C)  $\int_S \vec{F} \times d\vec{S} = \int_V \vec{\nabla} \cdot \vec{F} dV$

(D)  $\int_S \vec{F} \times d\vec{S} = \int_V \vec{\nabla} \times \vec{F} dV$

**Q.1.6** If a 400 V, 50 Hz, star connected, 3-phase squirrel cage induction motor is operated from a 400 V, 75 Hz supply, the torque that the motor can now provide while drawing rated current from the supply

(A) reduces

(B) increases

(C) remains the same

(D) increases or reduces depending upon the rotor resistance

**Q.1.7** A dc series motor fed from rated supply voltage is over-loaded and its magnetic circuit is saturated. The torque-speed characteristic of this motor will be approximately represented by which curve of figure ?

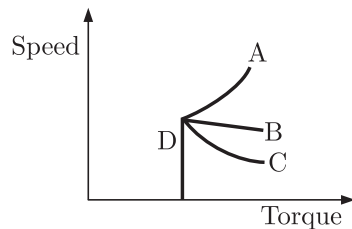

(A) Curve A

(B) Curve B

(C) Curve C

(D) Curve D

**Q.1.8** A 1 kVA, 230 V/100 V, single phase, 50 Hz transformer having negligible winding resistance and leakage inductance is operating under saturation, while 250 V, 50 Hz sinusoidal supply is connected to the high voltage winding. A resistive load is connected to the low voltage winding which draws rated current. Which one of the following quantities will not be sinusoidal ?

(A) Voltage induced across the low voltage winding

(B) Core flux

(C) Load current

(D) Current drawn from the source

**Q.1.9** A 400 V / 200 V / 200 V, 50 Hz three winding transformer is connected as shown in figure. The reading of the voltmeter,  $V$ , will be

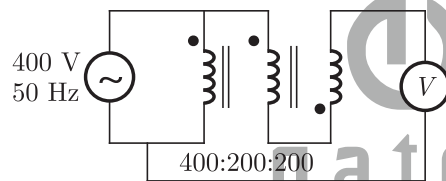

(A) 0 V

(B) 400 V

(C) 600 V

(D) 800 V

**Q.1.10** The frequency of the clock signal applied to the rising edge triggered D-flip-flop shown in Figure is 10 kHz. The frequency of the signal available at Q is.

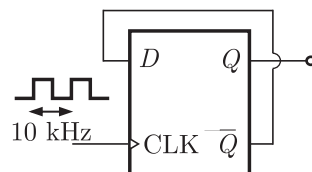

(A) 10 kHz

(B) 2.5 kHz

(C) 20 kHz

(D) 5 kHz

**Q.1.11** The forward resistance of the diode shown in Figure is  $5\ \Omega$  and the remaining parameters are same as those of an ideal diode. The dc component of the source current is

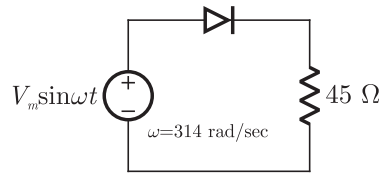

- (A)  $\frac{V_m}{50\pi}$                       (B)  $\frac{V_m}{50\pi\sqrt{2}}$
- (C)  $\frac{V_m}{100\pi\sqrt{2}}$                 (D)  $\frac{2V_m}{50\pi}$

**Q.1.12** The cut-in voltage of both zener diode  $D_Z$  and diode  $D$  shown in Figure is 0.7 V, while break-down voltage of  $D_Z$  is 3.3 V and reverse break-down voltage of  $D$  is 50 V. The other parameters can be assumed to be the same as those of an ideal diode. The values of the peak output voltage ( $V_o$ ) are

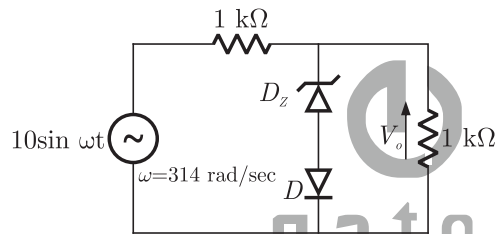

- (A) 3.3 V in the positive half cycle and 1.4 V in the negative half cycle.
- (B) 4 V in the positive half cycle and 5 V in the negative half cycle.
- (C) 3.3 V in both positive and negative half cycles.
- (D) 4 V in both positive and negative half cycle

**Q.1.13** The line-to-line input voltage to the 3-phase, 50 Hz, ac circuit shown in Figure is 100 V rms. Assuming that the phase sequence is RYB, the wattmeters would read.

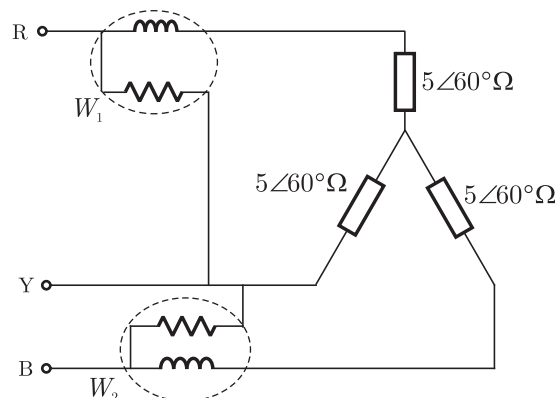

- (A)  $W_1=886$  W and  $W_2=886$  W      (B)  $W_1=500$  W and  $W_2=500$  W  
 (C)  $W_1=0$  W and  $W_2=1000$  W      (D)  $W_1=250$  W and  $W_2=750$  W

**Q.1.14** The logic circuit used to generate the active low chip select ( $\overline{CS}$ ) by an 8085 microprocessor to address a peripheral is shown in Figure. The peripheral will respond to addresses in the range.

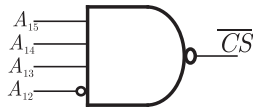

- (A) E000-EFFF      (B) 000E-FFFE  
 (C) 1000-FFFF      (D) 0001-FFF1

**Q.1.15** Consider a long, two-wire line composed of solid round conductors. The radius of both conductors is 0.25 cm and the distance between their centres is 1 m. If this distance is doubled, then the inductance per unit length

- (A) doubles  
 (B) halves  
 (C) increases but does not double  
 (D) decreases but does not halve

**Q.1.16** Consider a power system with three identical generators. The transmission losses are negligible. One generator (G1) has a speed governor which maintains its speed constant at the rated value, while the other generators (G2 and G3) have governors with a droop of 5%. If the load of the system is increased, then in steady state.

- (A) generation of G2 and G3 is increased equally while generation of G1 is unchanged.  
 (B) generation of G1 alone is increased while generation of G2 and G3 is unchanged.  
 (C) generation of G1, G2 and G3 is increased equally.  
 (D) generation of G1, G2 and G3 is increased in the ratio 0.5 : 0.25 : 0.25.

**Q.1.17** A long wire composed of a smooth round conductor runs above and parallel to the ground (assumed to be a large conducting plane). A high voltage exists between the conductor and the ground. The maximum electric stress occurs at

- (A) The upper surface of the conductor

- (B) The lower surface of the conductor.
- (C) The ground surface.
- (D) midway between the conductor and ground.

**Q.1.18** Consider the problem of relay co-ordination for the distance relays  $R1$  and  $R2$  on adjacent lines of a transmission system. The Zone-1 and Zone-2 settings for both the relays are indicated on the diagram. Which of the following indicates the correct time setting for the Zone-2 of relays  $R1$  and  $R2$ .

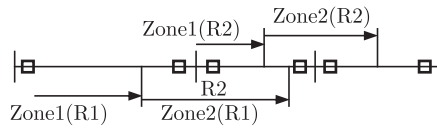

- (A)  $TZ2_{R1} = 0.6 \text{ s}, TZ2_{R2} = 0.3 \text{ s}$
- (B)  $TZ2_{R1} = 0.3 \text{ s}, TZ2_{R2} = 0.6 \text{ s}$
- (C)  $TZ2_{R1} = 0.3 \text{ s}, TZ2_{R2} = 0.3 \text{ s}$
- (D)  $TZ2_{R1} = 0.1 \text{ s}, TZ2_{R2} = 0.3 \text{ s}$

**Q.1.19** Let  $s(t)$  be the step response of a linear system with zero initial conditions; then the response of this system to an input  $u(t)$  is

- (A)  $\int_0^t s(t - \tau) u(\tau) d\tau$
- (B)  $\frac{d}{dt} \left[ \int_0^t s(t - \tau) u(\tau) d\tau \right]$
- (C)  $\int_0^t s(t - \tau) \left[ \int_0^t u(\tau_1) d\tau_1 \right] d\tau$
- (D)  $\int_0^1 [s(t - \tau)]^2 u(\tau) d\tau$

**Q.1.20** Let  $Y(s)$  be the Laplace transformation of the function  $y(t)$ , then the final value of the function is

- (A)  $\lim_{s \rightarrow 0} Y(s)$
- (B)  $\lim_{s \rightarrow \infty} Y(s)$
- (C)  $\lim_{s \rightarrow 0} sY(s)$
- (D)  $\lim_{s \rightarrow \infty} sY(s)$

**Q.1.21** The determinant of the matrix  $\begin{bmatrix} 1 & 0 & 0 & 0 \\ 100 & 1 & 0 & 0 \\ 100 & 200 & 1 & 0 \\ 100 & 200 & 300 & 1 \end{bmatrix}$  is

- (A) 100
- (B) 200
- (C) 1
- (D) 300

**Q.1.22** The state transition matrix for the system  $\dot{\mathbf{X}} = A\mathbf{X}$  with initial state  $\mathbf{X}(0)$  is

- (A)  $(sI - A)^{-1}$   
 (B)  $e^{At} \mathbf{X}(0)$   
 (C) Laplace inverse of  $[(sI - A)^{-1}]$   
 (D) Laplace inverse of  $[(sI - A)^{-1} \mathbf{X}(0)]$

**Q.1.23** A six pulse thyristor rectifier bridge is connected to a balanced 50 Hz three phase ac source. Assuming that the dc output current of the rectifier is constant, the lowest frequency harmonic component in the ac source line current is

- (A) 100 Hz  
 (B) 150 Hz  
 (C) 250 Hz  
 (D) 300 Hz

**Q.1.24** What is the rms value of the voltage waveform shown in Figure ?

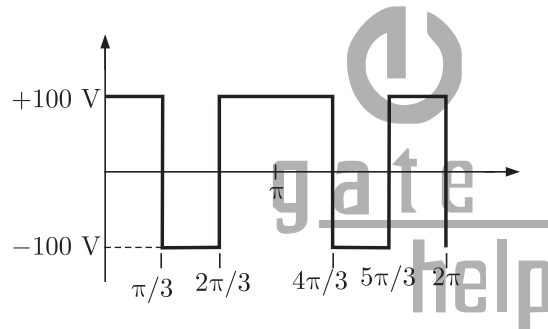

- (A)  $(200/\pi)$  V  
 (B)  $(100/\pi)$  V  
 (C) 200 V  
 (D) 100 V

**Q.1.25** A step-down chopper is operated in the continuous conduction mode in steady state with a constant duty ratio  $D$ . If  $V_0$  is the magnitude of the dc output voltage and if  $V_s$  is the magnitude of the dc input voltage, the ratio  $V_0/V_s$  is given by

- (A)  $D$   
 (B)  $1 - D$   
 (C)  $\frac{1}{1 - D}$   
 (D)  $\frac{D}{1 - D}$

**This question consists of TWENTY FIVE sub-questions (2.1-2.25) of TWO marks each. For each of these sub-questions, four choices (A, B, C and D) are given, out of which only one is correct. Indicate each sub-question by darkening the appropriate bubble on the OBJECTIVE RESPONSE SHEET (ORS) using a soft HB**

pencil. Do not use the ORS for any rough work. You may like to use the answer book for any rough work, if needed.

**Q.2.1** A two port network shown in Figure, is described by the following equations

$$I_1 = Y_{11}E_1 + Y_{12}E_2$$

$$I_1 = Y_{21}E_1 + Y_{22}E_2$$

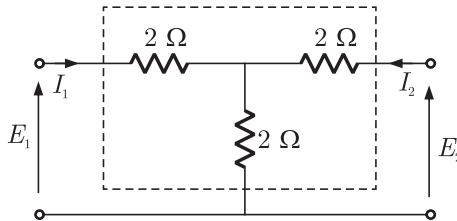

The admittance parameters,  $Y_{11}$ ,  $Y_{12}$ ,  $Y_{21}$  and  $Y_{22}$  for the network shown are

- (A) 0.5 mho, 1 mho, 2 mho and 1 mho respectively  
 (B)  $\frac{1}{3}$  mho,  $-\frac{1}{6}$  mho,  $-\frac{1}{6}$  mho and  $\frac{1}{3}$  mho respectively  
 (C) 0.5 mho, 0.5 mho, 1.5 mho and 2 mho respectively  
 (D)  $-\frac{2}{5}$  mho,  $-\frac{3}{7}$  mho,  $\frac{3}{7}$  mho and  $\frac{2}{5}$  mho respectively

**Q.2.2** In the circuit shown in Figure, what value of  $C$  will cause a unity power factor at the ac source ?

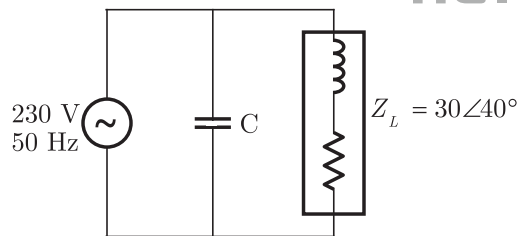

- (A) 68.1  $\mu\text{F}$  (B) 165  $\mu\text{F}$   
 (C) 0.681  $\mu\text{F}$  (D) 6.81  $\mu\text{F}$

**Q.2.3** A first order, low pass filter is given with  $R = 50 \Omega$  and  $C = 5 \mu\text{F}$ . What is the frequency at which the gain of the voltage transfer function of the filter is 0.25 ?

- (A) 4.92 kHz (B) 0.49 kHz  
 (C) 2.46 kHz (D) 24.6 kHz



**Q.2.4** A series R-L-C circuit has  $R = 50 \Omega$ ;  $L = 100 \mu\text{H}$  and  $C = 1 \mu\text{F}$ . The lower half power frequency of the circuit is

- (A) 30.55 kHz (B) 3.055 kHz  
(C) 51.92 kHz (D) 1.92 kHz

**Q.2.5** A 200 V, 2000 rpm, 10 A, separately excited dc motor has an armature resistance of  $2 \Omega$ . Rated dc voltage is applied to both the armature and field winding of the motor. If the armature drawn 5 A from the source, the torque developed by the motor is

- (A) 4.30 Nm (B) 4.77 Nm  
(C) 0.45 Nm (D) 0.50 Nm

**Q.2.6** The rotor of a three phase, 5 kW, 400 V, 50 Hz, slip ring induction motor is wound for 6 poles while its stator is wound for 4 poles. The approximate average no load steady state speed when this motor is connected to 400 V, 50 Hz supply is

- (A) 1500 rpm (B) 500 rpm  
(C) 0 rpm (D) 1000 rpm

**Q.2.7** The flux per pole in a synchronous motor with the field circuit ON and the stator disconnected from the supply is found to be 25 mWb. When the stator is connected to the rated supply with the field excitation unchanged, the flux per pole in the machine is found to be 20 mWb while the motor is running on no load. Assuming no load losses to be zero, the no load current drawn by the motor from the supply

- (A) lags the supply voltage  
(B) leads the supply voltage  
(C) is in phase with the supply voltage  
(D) is zero

**Q.2.8** A 10 V pulse of  $10 \mu\text{s}$  duration is applied to the circuit shown in Figure, assuming that the capacitor is completely discharged prior to applying the pulse, the peak value of the capacitor voltage is

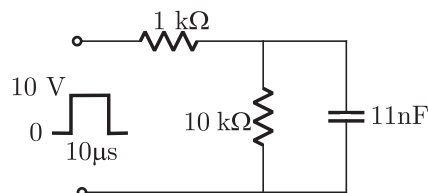

- (A) 11 V
- (B) 5.5 V
- (C) 6.32 V
- (D) 0.96 V

**Q.2.9** The output voltage ( $v_o$ ) of the Schmitt trigger shown in Figure swings between +15 V and -15 V. Assume that the operational amplifier is ideal. The output will change from +15 V to -15 V when the instantaneous value of the input sine wave is

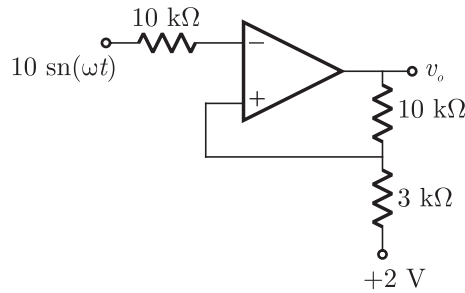

- (A) 5 V in the positive slope only
- (B) 5 V in the negative slope only
- (C) 5 V in the positive and negative slopes
- (D) 3 V in the positive and negative slopes.

**Q.2.10** For the circuit shown in Figure, the boolean expression for the output  $Y$  in terms of inputs  $P, Q, R$  and  $S$  is

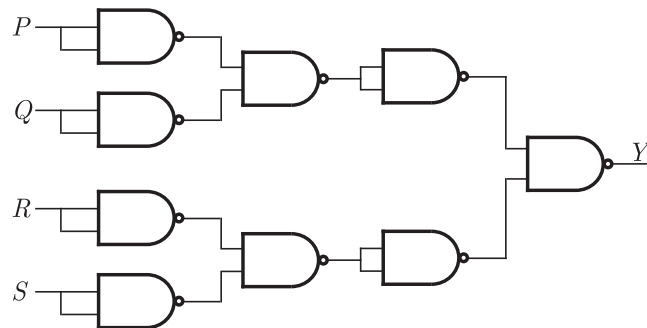

- (A)  $\bar{P} + \bar{Q} + \bar{R} + \bar{S}$
- (B)  $P + Q + R + S$
- (C)  $(\bar{P} + \bar{Q})(\bar{R} + \bar{S})$
- (D)  $(P + Q)(R + S)$

**Q.2.11** In the circuit shown in Figure, it is found that the input voltage ( $v_i$ ) and current  $i$  are in phase. The coupling coefficient is  $K = \frac{M}{\sqrt{L_1 L_2}}$ , where  $M$  is the mutual inductance between the two coils.

The value of  $K$  and the dot polarity of the coil P-Q are

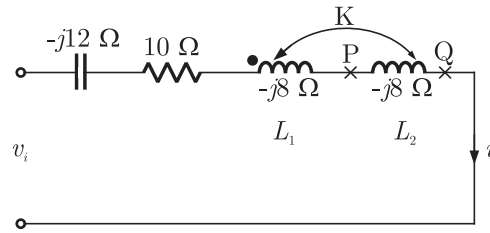

- (A)  $K = 0.25$  and dot at P
- (B)  $K = 0.5$  and dot at P
- (C)  $K = 0.25$  and dot at Q
- (C)  $K = 0.5$  and dot at Q

**Q.2.12** Consider the circuit shown in Figure If the frequency of the source is 50 Hz, then a value of  $t_0$  which results in a transient free response is

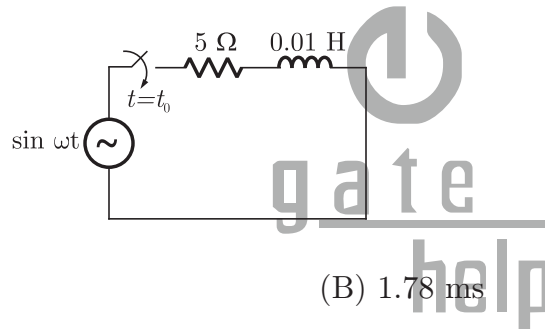

- (A) 0 ms
- (B) 1.78 ms
- (C) 2.71 ms
- (D) 2.91 ms

**Q.2.13** A three phase thyristor bridge rectifier is used in a HVDC link. The firing angle  $\alpha$  (as measured from the point of natural commutation) is constrained to lie between  $5^\circ$  and  $30^\circ$ . If the dc side current and ac side voltage magnitudes are constant, which of the following statements is true (neglect harmonics in the ac side currents and commutation overlap in your analysis)

- (A) Reactive power absorbed by the rectifier is maximum when  $\alpha = 5^\circ$
- (B) Reactive power absorbed by the rectifier is maximum when  $\alpha = 30^\circ$
- (C) Reactive power absorbed by the rectifier is maximum when  $\alpha = 15^\circ$
- (D) Reactive power absorbed by the rectifier is maximum when  $\alpha = 15^\circ$

**Q.2.14** A power system consist of 2 areas (area 1 and area 2) connected by a single tie-line. It is required to carry out a load-flow study on this system. While entering the network

data, the tie-line data (connectivity and parameters) is inadvertently left out. If the load flow program is run with this incomplete data



- (A) The load-flow will converge only if the slack bus is specified in area 1  
 (B) The load-flow will converge only if the slack bus is specified in area 2  
 (C) The load-flow will converge if the slack bus is specified in either area 1 or area 2  
 (D) The load-flow will not converge if only one slack is specified.

**Q.2.15** A transmission line has a total series reactance of 0.2 pu. Reactive power compensation is applied at the midpoint of the line and it is controlled such that the midpoint voltage of the transmission line is always maintained at 0.98 pu. If voltage at both ends of the line are maintained at 1.0 pu, then the steady state power transfer limit of the transmission line is

- (A) 9.8 pu  
 (B) 4.9 pu  
 (C) 19.6 pu  
 (D) 5 pu

**Q.2.16** A generator is connected to a transformer which feeds another transformer through a short feeder (see figure). The zero sequence impedance values expressed in pu on a common base and are indicated in figure. The Thevenin equivalent zero sequence impedance at point B is

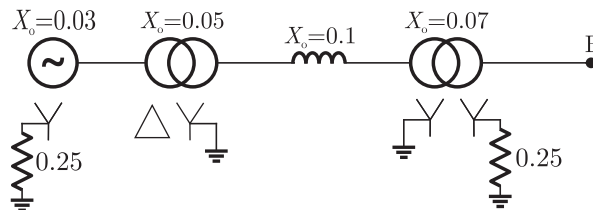

- (A)  $0.8 + j0.6$   
 (B)  $0.75 + j0.22$   
 (C)  $0.75 + j0.25$   
 (D)  $1.5 + j0.25$

**Q.2.17** For the system  $\dot{\mathbf{X}} = \begin{bmatrix} 2 & 3 \\ 0 & 5 \end{bmatrix} \mathbf{X} + \begin{bmatrix} 1 \\ 0 \end{bmatrix} \mathbf{u}$ , which of the following statements is true ?

- (A) The system is controllable but unstable  
 (B) The system is uncontrollable and unstable

- (C) The system is controllable and stable  
 (D) The system is uncontrollable and stable

**Q.2.18** A unity feedback system has an open loop transfer function,  $G(s) = \frac{K}{s^2}$ . The root locus plot is

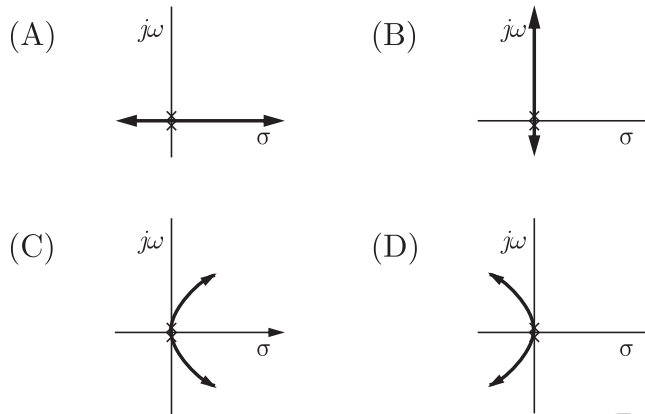

**Q.2.19** The transfer function of the system described by

$$\frac{d^2 y}{dt^2} + \frac{dy}{dt} = \frac{du}{dt} + 2u$$

with  $u$  as input and  $y$  as output is

- (A)  $\frac{(s+2)}{(s^2+s)}$  (B)  $\frac{(s+1)}{(s^2+s)}$   
 (C)  $\frac{2}{(s^2+s)}$  (D)  $\frac{2s}{(s^2+s)}$

**Q.2.20** For the system

$$\dot{\mathbf{X}} = \begin{bmatrix} 2 & 0 \\ 0 & 4 \end{bmatrix} \mathbf{X} + \begin{bmatrix} 1 \\ 1 \end{bmatrix} \mathbf{u}; \mathbf{Y} = [4 \ 0] \mathbf{X},$$

with  $u$  as unit impulse and with zero initial state, the output  $y$ , becomes

- (A)  $2e^{2t}$  (B)  $4e^{2t}$   
 (C)  $2e^{4t}$  (D)  $4e^{4t}$

**Q.2.21** The eigen values of the system represented by

$$\dot{\mathbf{X}} = \begin{bmatrix} 0 & 1 & 0 & 0 \\ 0 & 0 & 1 & 0 \\ 0 & 0 & 0 & 1 \\ 0 & 0 & 0 & 1 \end{bmatrix} \mathbf{X} \text{ are}$$

- (A) 0, 0, 0, 0
- (B) 1, 1, 1, 1
- (C) 0, 0, 0, -1
- (D) 1, 0, 0, 0

**Q.2.22** In the chopper circuit shown in figure, the input dc voltage has a constant value  $V_s$ . The output voltage  $V_0$  is assumed ripple-free. The switch  $S$  is operated with a switching time period  $T$  and a duty ratio  $D$ . What is the value of  $D$  at the boundary of continuous and discontinuous conduction of the inductor current  $i_L$ ?

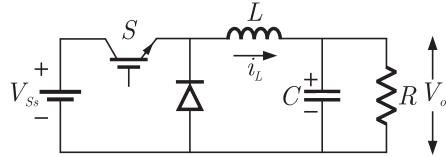

- (A)  $D = 1 - \frac{V_s}{V_0}$
- (B)  $D = \frac{2L}{RT}$
- (C)  $D = 1 - \frac{2L}{RT}$
- (D)  $D = \frac{RT}{L}$

**Q.2.23** Figure(a) shows an inverter circuit with a dc source voltage  $V_s$ . The semiconductor switches of the inverter are operated in such a manner that the pole voltage  $V_{10}$  and  $V_{20}$  are as shown in figure(b). What is the rms value of the pole-to-pole voltage  $V_{12}$ ?

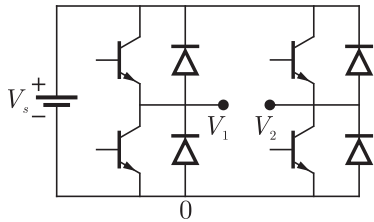

Figure (a)

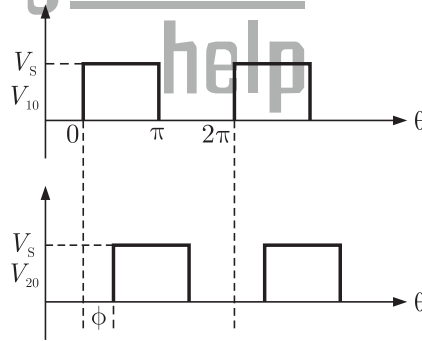
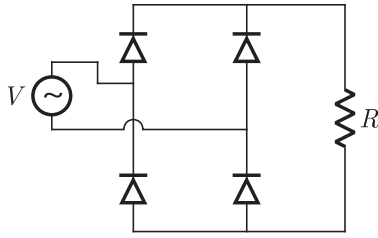

Figure (b)

- (A)  $\frac{V_s \phi}{\pi \sqrt{2}}$
- (B)  $V_s \sqrt{\frac{\phi}{\pi}}$
- (C)  $V_s \sqrt{\frac{\phi}{2\pi}}$
- (D)  $\frac{V_s}{\pi}$

**Q.2.24** In the single phase diode bridge rectifier shown in figure, the load resistor is  $R = 50 \Omega$ . The source voltage is  $V = 200 \sin(\omega t)$ , where  $\omega = 2\pi \times 50$  radians per second. The power dissipated in the load resistor  $R$  is



- (A)  $\frac{3200}{\pi}$  W                      (B)  $\frac{400}{\pi}$  W  
 (C) 400 W                              (D) 800 W

**Q.2.25** In the circuit shown in figure, the switch is closed at time  $t = 0$ . The steady state value of the voltage  $v_c$  is

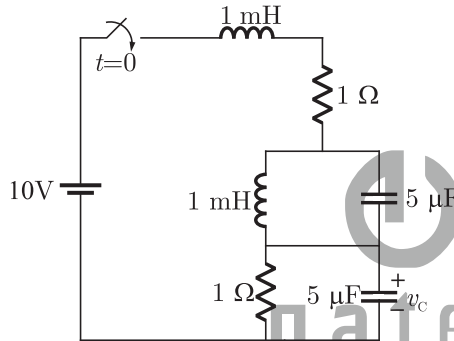

- (A) 0 V                                      (B) 10 V  
 (C) 5 V                                      (D) 2.5 V

### Section-B

**This section consists of TWENTY questions of FIVE marks each. ANY FIFTEEN out of them have to be answered. If more than fifteen questions are attempted, score off answers that are not to be evaluated. Otherwise only the first fifteen unscored answers will be considered.**

**Q.3** The magnetic vector potential in a region is defined by  $\vec{A} = e^{-y} \sin(x) \hat{a}_z$ . An infinitely long conductor, having a cross section area,  $a = 5 \text{ mm}^2$  and carrying a dc current,  $I = 5 \text{ A}$  in the  $y$  direction, passes through this region as shown in Fig. P3.

Determine the expression for (a)  $\vec{B}$  and (b) force density  $\vec{f}$  exerted on the conductor.

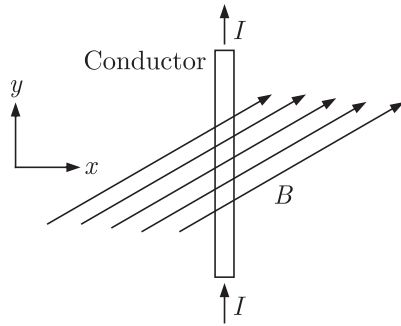

**Q.4** A constant current source is supplying 10 A to a circuit shown in Fig. P4. The switch  $S$ , which is initially closed for a sufficiently long time, is suddenly opened. Obtain the differential equation governing the behaviour of the inductor current and hence obtain the complete time response of the inductor current. What is the energy stored in  $L$ , a long time after the switch is opened?

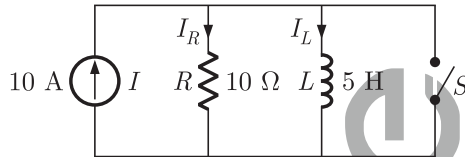

**Q.5** An electrical network is fed by two ac sources, as shown in Fig. P5. Given that  $Z_1 = (1 - j)\Omega$ ,  $Z_2 = (1 - j)\Omega$  and  $Z_L = (1 + j0)\Omega$ . Obtain the Thevenin equivalent circuit (Thevenin voltage and impedance) across terminals  $x$  and  $y$ , and determine the current  $I_L$  through the load  $Z_L$ .

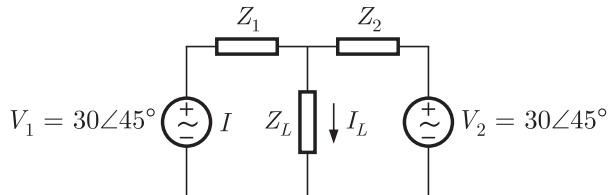

**Q.6** In the resistor network shown in Fig. P6, all resistor values are  $1\Omega$ . A current of 1 A passes from terminal a to terminal b, as shown in the figure. Calculate the voltage between terminals a and b. [Hint : You may exploit the symmetry of the circuit].



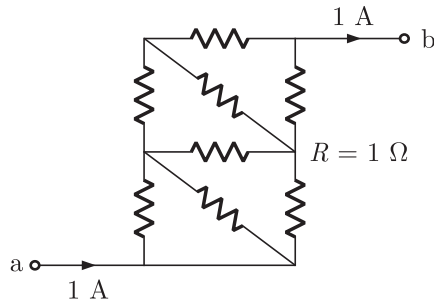

**Q.7** A 230 V, 250 rpm, 100 A separately excited dc motor has an armature resistance of  $0.5 \Omega$ . The motor is connected to 230 V dc supply and rated dc voltage is applied to the field winding. It is driving a load whose torque-speed characteristic is given by  $T_L = 500 - 10 \omega$ , where  $\omega$  is the rotational speed expressed in rad/sec and  $T_L$  is the load torque in Nm. Find the steady state speed at which the motor will drive the load and the armature current drawn by it from the source. Neglect the rotational losses of the machine.

**Q.8** A single phase 6300 kVA, 50 Hz, 3300 V/ 400 V distribution transformer is connected between two 50 Hz supply systems, A and B as shown in figure. The transformer has 12 and 99 turns in the low and high voltage windings respectively. The magnetizing reactance of the transformer referred to the high voltage side is  $500 \Omega$ . The leakage reactance of the high and low voltage windings are  $1.0 \Omega$  and  $0.012 \Omega$  respectively. Neglect the winding resistance and core losses of the transformer. The Thevenin voltage of system A is 3300 V while that of system B is 400 V. The short circuit reactance of system A and B are  $0.5 \Omega$  and  $0.010 \Omega$  respectively. If no power is transferred between A and B, so that the two system voltages are in phase, find the magnetizing ampere turns of the transformer.

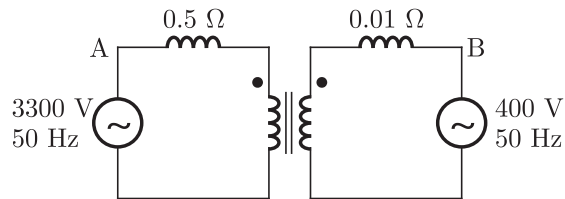

**Q.9** A 440 V, 50 Hz, 6 pole, 960 rpm star connected induction machine has the following per phase parameters referred to the stator :

$$R_s = 0.6 \Omega, R_r = 0.3 \Omega, X_s = 1 \Omega$$

The magnetizing reactance is very high and is neglected. The machine is connected to the 440 V, 50 Hz supply and a certain mechanical load is coupled to it. It is found that the magnitude of the stator current is equal to the rated current of the machine but the machine is running at a speed higher than its rated speed. Find the speed at which the machine is running. Also find the torque developed by the machine.

**Q.10** A 415 V, 2-pole, 3-phase, 50 Hz, star connected, non-salient pole synchronous motor has synchronous reactance of  $2 \Omega$  per phase and negligible stator resistance. At a particular field excitation, it draws 20 A at unity power factor from a 415 V, 3-phase, 50 Hz supply. The mechanical load on the motor is now increased till the stator current is equal to 50 A. The field excitation remains unchanged. Determine :

- (A) the per phase open circuit voltage  $E_0$
- (B) the developed power for the new operating condition and corresponding power factor.

**Q.11** For the circuit shown in Figure,  $I_E = 1 \text{ mA}$ ,  $\beta = 99$  and  $V_{BE} = 0.7 \text{ V}$

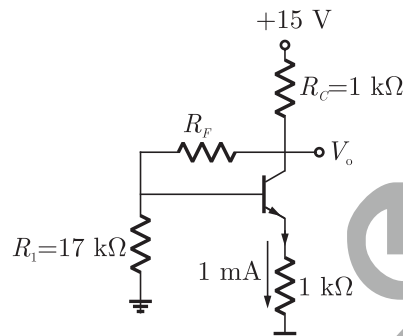

- (A) the current through  $R_1$  and  $R_C$
- (B) the output voltage  $V_0$
- (C) the value of  $R_F$

**Q.12** Determine the transfer function  $\left(\frac{V_y}{V_x}\right)$  for the RC network shown in Fig. P12 (A) This network is used as a feedback circuit in an oscillator circuit shown in Fig. P12(B) to generate sinusoidal oscillations. Assuming that the operational amplifier is ideal, determine  $R_F$  for generating these oscillations. Also, determine the oscillation frequency if  $R = 10 \text{ k}\Omega$  and  $C = 100 \text{ pF}$ .

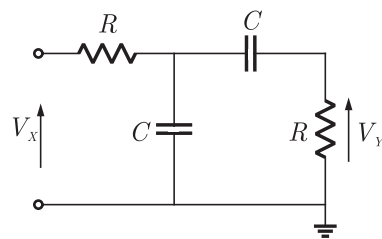

Figure (a)

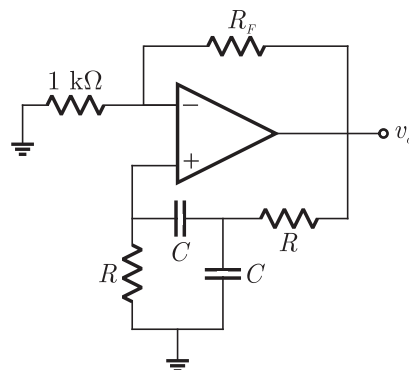

Figure (b)

**Q.13** The ripple counter shown in figure is made up of negative edge triggered J-K flip-flops. The signal levels at  $J$  and  $K$  inputs of all the flip flops are maintained at logic 1. Assume all the outputs are cleared just prior to applying the clock signal.

- (A) Create a table of  $Q_0, Q_1, Q_2$  and  $A$  in the format given below for 10 successive input cycles of the clock CLK1.
- (B) Determine the module number of the counter.
- (C) Modify the circuit of Fig. P13 to create a modulo-6 counter using the same components used in the figure.

Format for (A) :

CLK 1	$Q_1$	$Q_2$	$Q_3$	$Q_4$

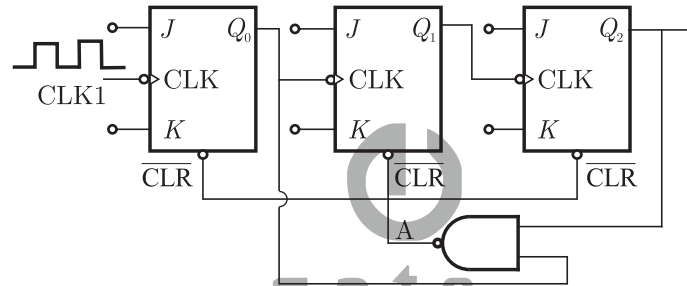

**Q.14** A long lossless transmission line has a unity power factor (UPF) load at the receiving end and an ac voltage source at the sending end. The parameters of the transmission line are as follows :

Characteristic impedance  $Z_c = 400 \Omega$ , propagation constant  $\beta = 1.2 \times 10^{-3}$  rad/km, and the length  $l = 100$  km. The equation relating sending and receiving end questions is

$$V_s = V_r \cos(\beta l) + jZ_c \sin(\beta l) I_R$$

Compute the maximum power that can be transferred to the UPF load at the receiving end if  $|V_s| = 230$  kV

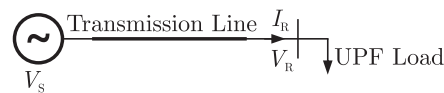

**Q.15** Two transposed 3-phase lines run parallel to each other. The equation describing the voltage drop in both lines is given below.

$$\begin{bmatrix} \Delta V_{a1} \\ \Delta V_{b1} \\ \Delta V_{c1} \\ \Delta V_{a2} \\ \Delta V_{b2} \\ \Delta V_{c2} \end{bmatrix} = j \begin{bmatrix} 0.15 & 0.05 & 0.05 & 0.04 & 0.04 & 0.04 \\ 0.05 & 0.15 & 0.05 & 0.04 & 0.04 & 0.04 \\ 0.05 & 0.05 & 0.15 & 0.04 & 0.04 & 0.04 \\ 0.04 & 0.04 & 0.04 & 0.15 & 0.05 & 0.05 \\ 0.04 & 0.04 & 0.04 & 0.05 & 0.15 & 0.05 \\ 0.04 & 0.04 & 0.04 & 0.05 & 0.05 & 0.15 \end{bmatrix} \begin{bmatrix} I_{a1} \\ I_{b1} \\ I_{c1} \\ I_{a2} \\ I_{b2} \\ I_{c2} \end{bmatrix}$$

Compute the self and mutual zero sequence impedance of this system i.e. compute  $Z_{011}, Z_{012}, Z_{021}, Z_{022}$  in the following equations.

$$\Delta V_{01} = Z_{011} I_{01} + Z_{012} I_{02}$$

$$\Delta V_{02} = Z_{021} I_{01} + Z_{022} I_{02}$$

Where  $\Delta V_{01}, \Delta V_{02}, I_{01}, I_{02}$  are the zero sequence voltage drops and currents for the two lines respectively.

**Q.16** A synchronous generator is to be connected to an infinite bus through a transmission line of reactance  $X = 0.2$  pu, as shown in figure. The generator data is as follows :

$x' = 0.1$  pu,  $E' = 1.0$  pu,  $H = 5$  MJ/MVA, mechanical power  $P_m = 0.0$  pu,  $\omega_B = 2\pi \times 50$  rad/s. All quantities are expressed on a common base.

The generator is initially running on open circuit with the frequency of the open circuit voltage slightly higher than that of the infinite bus. If at the instant of switch closure,  $\delta = 0$  and  $\omega = \frac{d\delta}{dt} = \omega_{init}$ , compute the maximum value of  $\omega_{init}$  so that the generator pulls into synchronism.

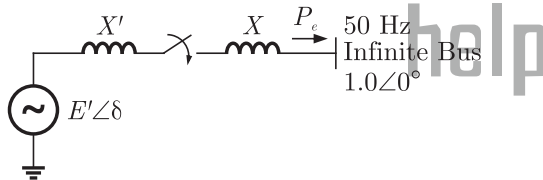

Hint : Use the equation  $\int (2H/\omega_B) \omega d\omega + P_e d\delta = 0$

**Q.17** A single input single output system with  $y$  as output and  $u$  as input, is described by

$$\frac{d^2 y}{dt^2} + 2 \frac{dy}{dt} + 10y = 5 \frac{du}{dt} - 3u$$

For the above system find an input  $u(t)$ , with zero initial condition, that produces the same output as with no input and with the initial conditions.

$$\frac{dy(0^-)}{dt} = -4, y(0^-) = 1$$

**Q.18** Obtain a state variable representation of the system governed by the differential equation :

$$\frac{d^2 y}{dt^2} + \frac{dy}{dt} - 2y = u(t) e^{-1},$$

with the choice of state variables as  $x_1 = y$ ,  $x_2 = \left(\frac{dy}{dt} - y\right)e^t$ . Also find  $x_2(t)$ , given that  $u(t)$  is a unit step function and  $x_2(0) = 0$ .

**Q.19** The open loop transfer function of a unity feedback system is given by

$$G(s) = \frac{2(s + \alpha)}{s(s + 2)(s + 10)}$$

Sketch the root locus as  $\alpha$  varies from 0 to  $\infty$ . Find the angle and real axis intercept of the asymptotes, breakaway points and the imaginary axis crossing points, if any.

**Q.20** In Figure , the ideal switch  $S$  is switched on and off with a switching frequency  $f = 10$  kHz. The switching time period is  $T = t_{ON} + t_{OFF}$   $\mu$ s. The circuit is operated in steady state at the boundary of continuous and discontinuous conduction, so that the inductor current  $i$  is as shown in Figure. P20. Find

- (A) The on-time  $t_{ON}$  of the switch.  
 (B) The value of the peak current  $I_P$ .

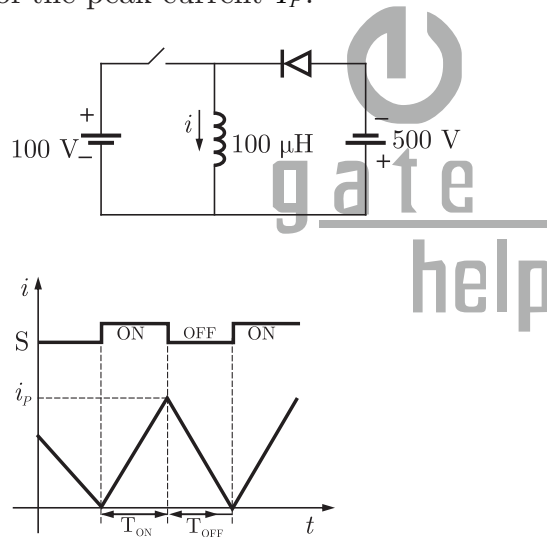

**Q.21** In the circuit shown in Figure, the source  $I$  is a dc current source. The switch  $S$  is operated with a time period  $T$  and a duty ratio  $D$ . You may assume that the capacitance  $C$  has a finite value which is large enough so that the voltage  $V_C$  has negligible ripple, calculate the following under steady state conditions, in terms of  $D$ ,  $I$  and  $R$ .

- (A) The voltage  $V_C$ , with the polarity shown in Figure. P21.  
 (B) The average output voltage  $V_0$ , with the polarity shown.

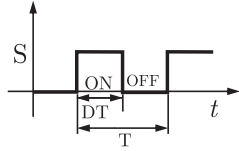
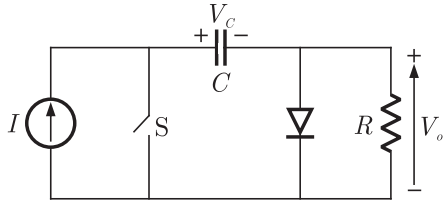

**Q.22** The semiconductor switch  $S$  in the circuit of figure is operated at a frequency of 20 kHz and a duty ratio  $D = 0.5$ . The circuit operates in the steady state. Calculate the power transferred from the dc voltage source  $V_1$  to the dc voltage source  $V_2$ .

